



HORBO SWIMMING POOL AND SPA EQUIPMENT



**EXCELLENT
PERFORMAN**



**HIGH
TECHNOLOG**



**EASY
MAINTENANCE**

CONTENT

WALL-MOUNTED FILTER	1-10
INGROUND FILTER	11-23
SAND FILTER SERIES	24-31
PUMP SERIES	32-39
UNDERWATER LIGHT SERIES	40-48
SPA SERIES	49-57
MACHINE ROOM EQUIPMENT	58-68
POOL SURROUNDING ACCESSORIES	69-78
LADDER SERIES	79-82
CLEANING EQUIPMENT	83-87
SAUNA SERIES	88-100
STEAM ROOM SERIES	101-105
LEISURE FURNITURE SERIES	106-107
SPA HOT TUB SERIES	108-118



WALL-MOUNTED FILTER

Model : HPK8020
(Children Swimming Pool)

The enclosure of wall-mounted filter is made of high quality Acrylic, so the filter is anti-acid anti-fading, and easy to clean. Integrated filter installation without room, simple installation, convenient operation, excellent performance, thereby reducing the construction cost. The filter is made according to Countries codes and standards



TECHNICAL CHARACTERISTICS

Dimensions	1110x670x780mm	
Flow rate	10m ³ /h	15m ³ /h
Voltage	220V/50Hz or 60Hz	
Precision of filtration bag	≤5μ	
Operating noise	≤50Db	
Material	Acrylic	
Installation	Wall mounted	

EQUIPMENT

Filtration Pump	1x1HP	1x1.5HP
Filtration basket with bag	1pc	
Chlorine feeder	1pc	
Light (Warm white)	1xLED	12W/12V
Time controller	1pc	
Swim jet	2pcs	
Handle rail (S.S.)	2pcs	
Ozone (optional)	1pc	(options)

SYSTEM

Filtration system	1pc
Disinfection system	1pc
Time control system	1pc
Circle system	1pc
Lighting system	1pc

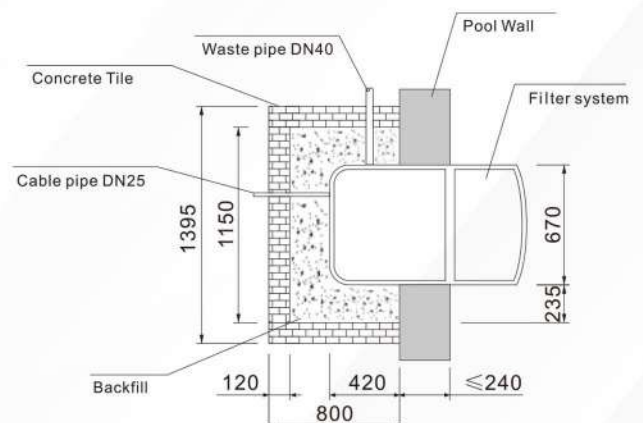
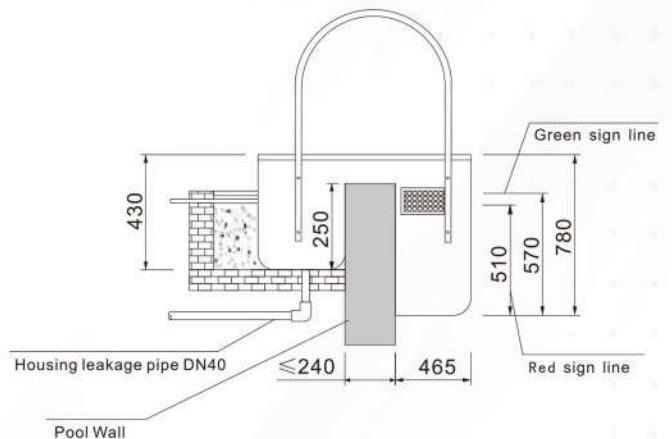



WALL-MOUNTED FILTER

Model : HPK8025
(Children Swimming Pool)

The enclosure of wall-mounted filter is made of high quality Acrylic, so the filter is anti-acid anti-fading, and easy to clean. Integrated filter installation without room, simple installation, convenient operation, excellent performance, thereby reducing the construction cost. The filter is made according to Countries codes and standards.



- 1 Stainless-steel hand rail
- 2 Cable pipe
- 3 Transformer and terminal box
- 4 Sewage pipe
- 5 Cartridge filter
- 6 Sterilizer
- 7 Injector nozzle
- 8 Swimming pool lamp
- 9 Water inlet
- 10 Water outlet
- 11 Hoarding
- 12 Concrete
- 13 Poolside tile

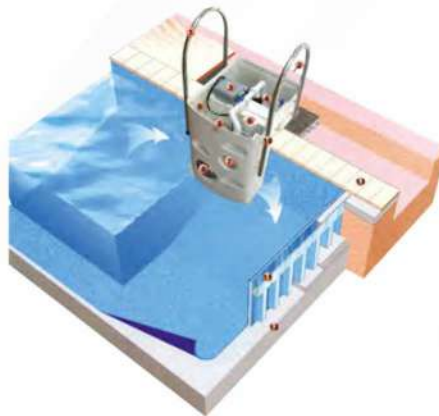

TECHNICAL CHARACTERISTICS

Dimensions	1120x690x1100mm
Flow rate	25m ³ /h
Voltage	220V/50Hz or 60Hz
Precision of filtration bag	≤5μ
Operating noise	≤50Db
Material	Acrylic
Installation	Wall mounted

EQUIPMENT

Filtration Pump	1x2HP	
Filtration basket with bag	1pc	
Chlorine feeder	1pc	
Light (Warm white)	1xLED	12W/12V
Time controller	1pc	
Swim jet	2pcs	
Handle rail (S.S.)	2pcs	
Ozone (optional)	1pc	(options)

SYSTEM

Filtration system	1pc
Disinfection system	1pc
Time control system	1pc
Circle system	1pc
Lighting system	1pc

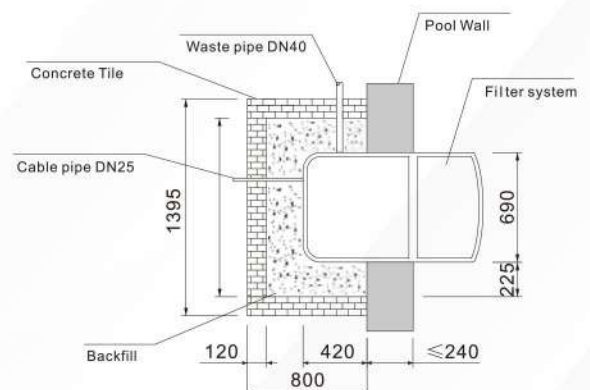
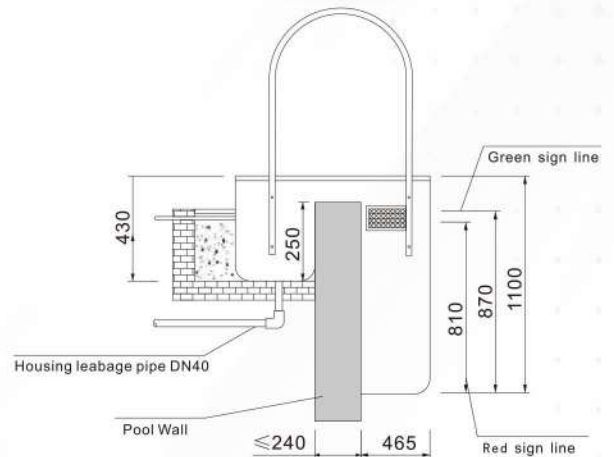



WALL-MOUNTED FILTER

Model : HPK8022
(Children Swimming Pool)

The enclosure of wall-mounted filter is made of ABS , so the filter is anti-acid anti-fading, and easy to clean Integrated filter installation without room, simple installation convenient operation, excellent performance, thereby reducing the construction cost. The filter is made according to Countries codes and standards.



TECHNICAL CHARACTERISTICS

Dimensions	1450x530x1060mm
Flow rate	25m ³ /h
Voltage	220V/50Hz or 60Hz
Precision of filtration bag	≤5μ
Operating noise	≤50Db
Material	ABS
Installation	Wall mounted

EQUIPMENT

Filtration Pump	1x2HP	
Filtration basket with bag	1pc	
Light (Warm white)	1xLED	12W/12V
Time controller	1pc	
Swim jet	2pcs	
Ozone (optional)	1pc	

SYSTEM

Filtration system	1pc
Disinfection system	1pc
Time control system	1pc
Circle system	1pc
Lighting system	1pc

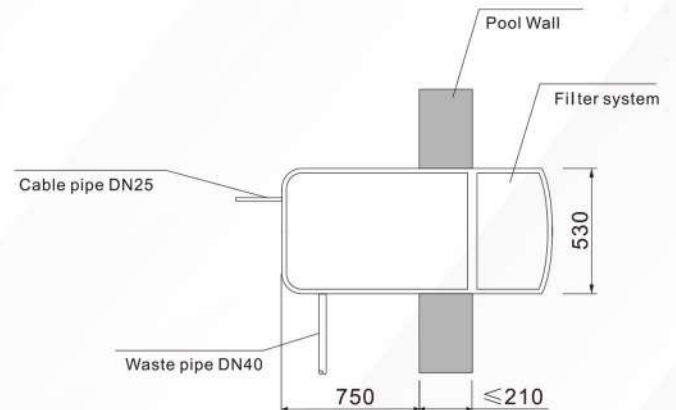
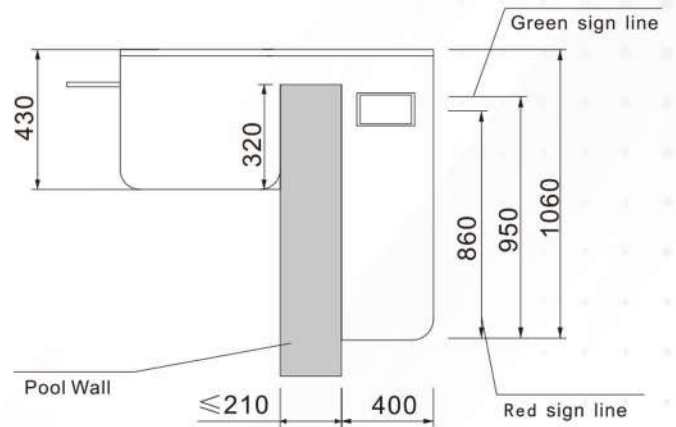



WALL-MOUNTED FILTER

Model : HPK8026
(Children Swimming Pool)

The enclosure of wall-mounted filter is made of high quality Acrylic, so the filter is anti-acid anti-fading, and easy to clean. Integrated filter installation without room, simple installation, convenient operation, excellent performance, thereby reducing the construction cost. The filter is made according to Countries codes and standards.



TECHNICAL CHARACTERISTICS

Dimensions	1150x710x1090mm
Flow rate	25m ³ /h 35m ³ /h
Voltage	220V/50Hz or 60Hz
Precision of filtration bag	≤5μ
Operating noise	≤50Db
Material	Acrylic
Installation	Wall mounted

EQUIPMENT

Filtration Pump	1x2HP	1x3HP
Filtration basket with bag	1pc	2pcs
Chlorine Feeder	1pc	
Light (Warm white)	1xLED	12W / 12V
Time controller	1pc	
Swim jet	2pcs	
Handle rail (S.S)	2pcs	
Ozone (optional)	1pc	Options

SYSTEM

Filtration system	1pc
Disinfection system	1pc
Time control system	1pc
Circle system	1pc
Lighting system	1pc

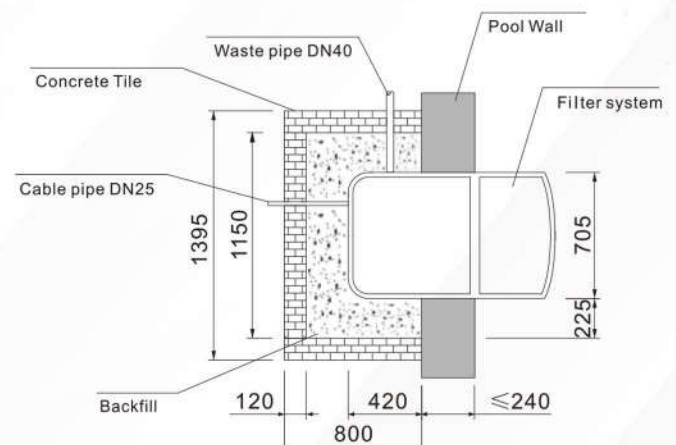
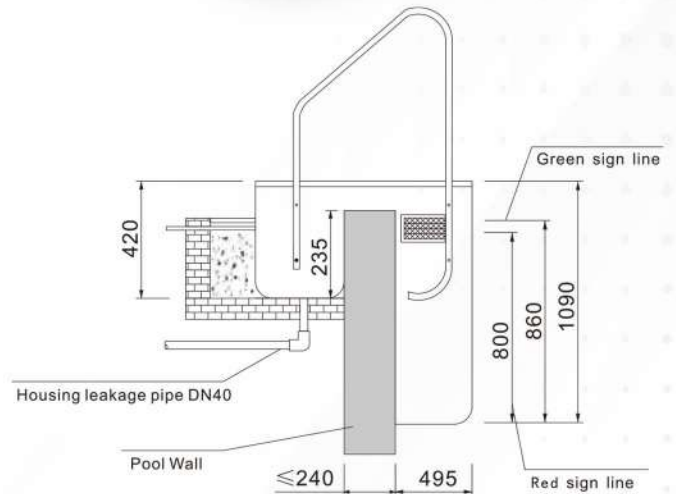



WALL-MOUNTED FILTER

Model : HPK8028
(Children Swimming Pool)

The enclosure of wall-mounted filter is made of high quality Acrylic, so the filter is anti-acid anti-fading, and easy to clean. Integrated filter installation without room, simple installation, convenient operation, excellent performance, thereby reducing the construction cost. The filter is made according to Countries codes and standards.



LEAF BASKET



SPRAY NOZZLE



CHLORINE FEEDER



INJECTOR NOZZLE



LED UNDERWATER LIGHT



FILTER BAG



TECHNICAL CHARACTERISTICS

Dimensions	1150x710x1090mm
Flow rate	25m ³ /h 35m ³ /h
Voltage	220V/50Hz or 60Hz
Precision of filtration bag	≤5μ
Operating noise	≤50Db
Material	Acrylic
Installation	Wall mounted

EQUIPMENT

Filtration Pump	1x2HP	1x3HP
Filtration basket with bag	1pc	2pcs
Chlorine Feeder	1pc	
Light (Warm white)	1xLED	12W / 12V
Time controller	1pc	
Swim jet	2pcs	
Handle rail (S.S)	2pcs	
Ozone (optional)	1pc	Options

SYSTEM

Filtration system	1pc
Disinfection system	1pc
Time control system	1pc
Circle system	1pc
Lighting system	1pc

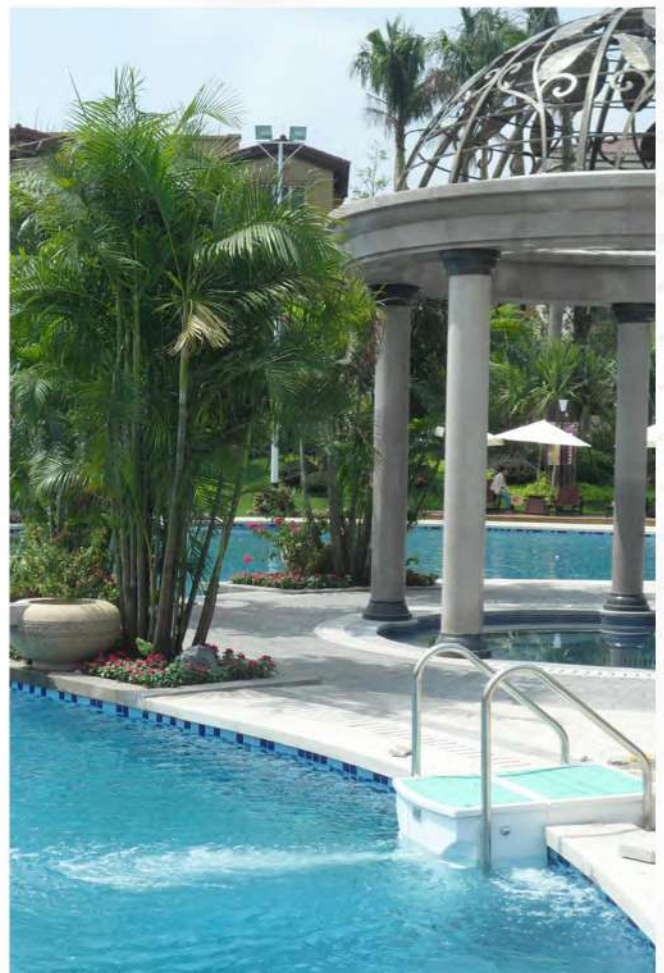



WALL-MOUNTED FILTER

Model : HPK8023
(Children Swimming Pool)

The enclosure of wall-mounted filter is made of high quality Acrylic. The wall-mounted filter is change to traditional sand filter. Now the filter installation without room, simple installation, convenient operation, excellent performance, thereby reducing the construction cost. The filter is made according to Countries codes and standards.

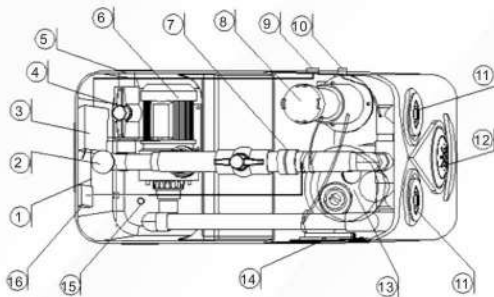

1	Filter shell	9	Make air controller on/off
2	Water injector	10	Air controller on/off
3	Control box	11	Spa jet
4	Drain valve	12	Pool light
5	Drain water pipe	13	Water filter
6	Water pump	14	Water inlet
7	Active connector	15	Pressure water purifier
8	Chlorinator feeder	16	Ozone disinfection

TECHNICAL CHARACTERISTICS

Dimensions	1050x550x860mm
Flow rate	10m ³ /h
Voltage	220V/50Hz or 60Hz
Precision of filtration bag	≤5μ
Operating noise	≤50Db
Material	Acrylic
Installation	Wall mounted

EQUIPMENT

Filtration Pump	1x1HP	
Filtration basket with bag	1pc	
Chlorine Feeder	1pc	
Light (Warm white)	1xLED	12W / 12V
Time controller	1pc	
Swim jet	2pcs	
Ozone (optional)	1pc	Options

SYSTEM

Filtration system	1pc
Disinfection system	1pc
Time control system	1pc
Circle system	1pc
Lighting system	1pc

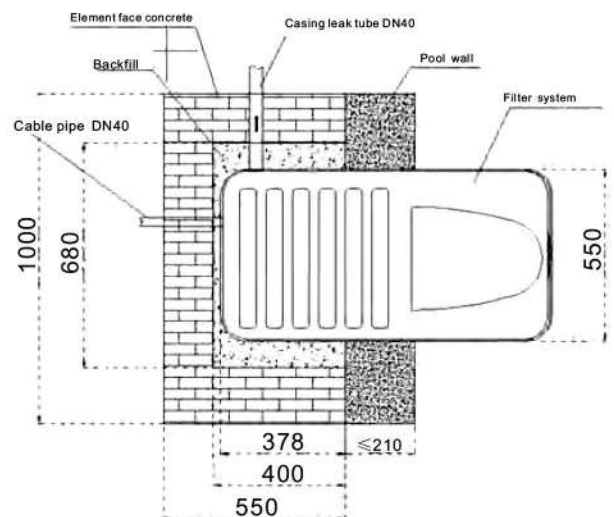
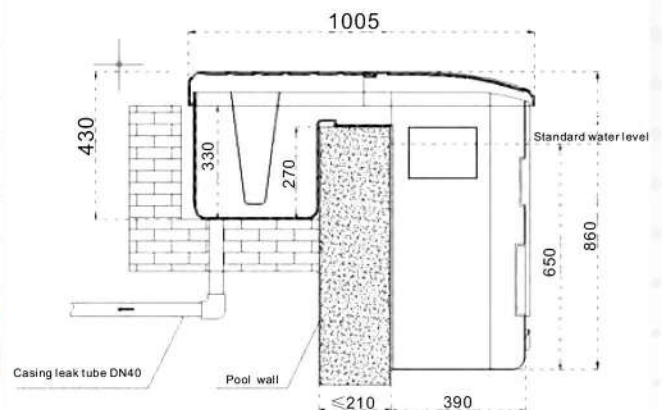



WALL-MOUNTED FILTER

Model : HPK8030
(Children Swimming Pool)

The enclosure of wall-mounted filter is made of high quality Acrylic, so the filter is anti-acid anti-fading, and easy to clean. Integrated filter installation without room, simple installation, convenient operation, excellent performance, thereby reducing the construction cost. It's big flow rate for 8pes filter bag.

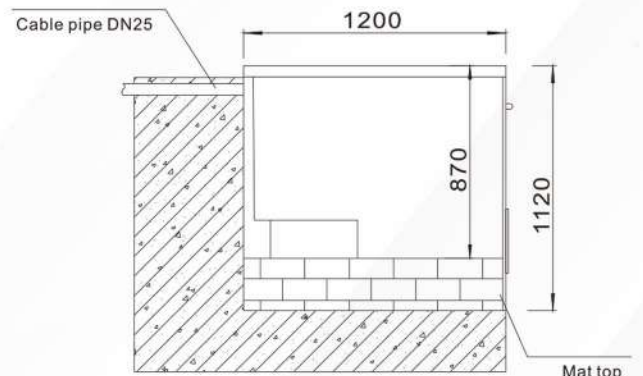
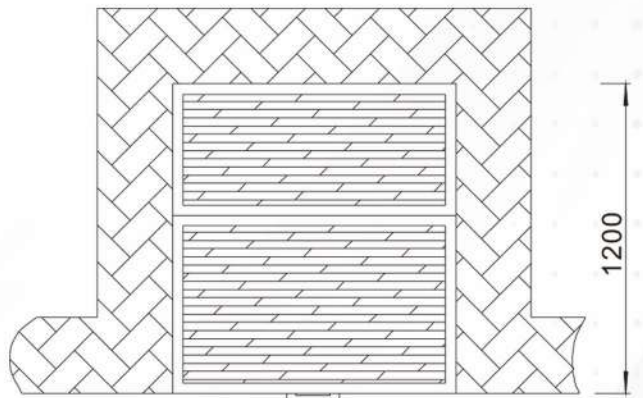
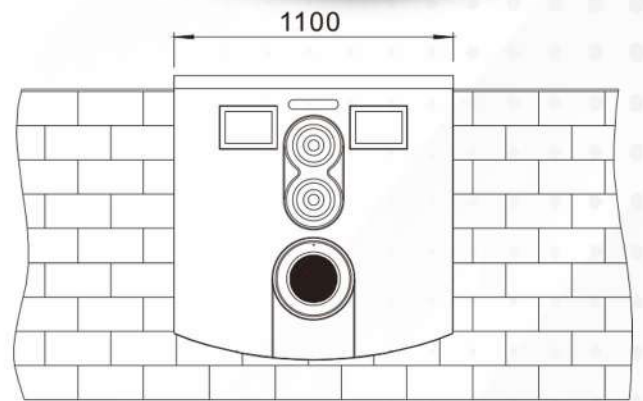
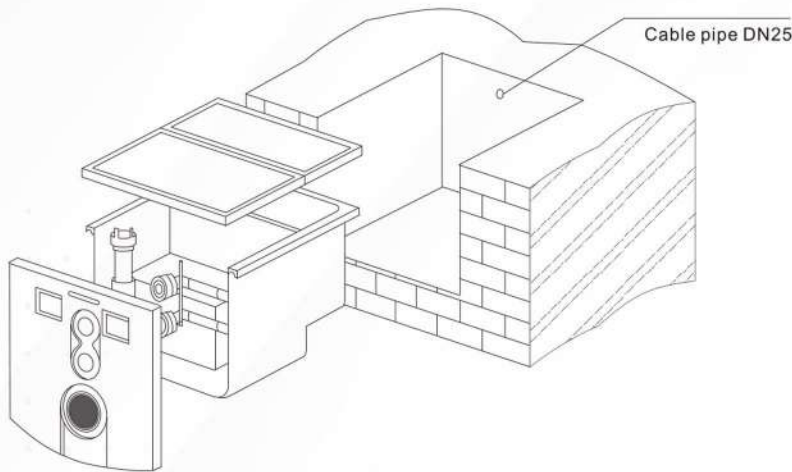

TECHNICAL CHARACTERISTICS

Dimensions	1100x1200x1120mm
Flow rate	47m ³ /h
Voltage	220V/50Hz or 60Hz
Precision of filtration bag	≤5μ
Operating noise	≤50Db
Material	Acrylic
Installation	Inground

EQUIPMENT

Filtration Pump	1x4HP	
Filtration basket with bag	8pc	
Chlorine Feeder	1pc	
Light (Warm white)	1xLED	12W / 12V
Time controller	1pc	
Swim jet	2pcs x 5"	

SYSTEM

Filtration system	1pc
Disinfection system	1pc
Time control system	1pc
Circle system	1pc
Lighting system	1pc



WALL-MOUNTED FILTER

Model : HPK8021 (Children Swimming Pool)

The enclosure of wall-mounted filter is made of high quality Polyethylene. The wall-mounted filter is change to traditional sand filter. Now the filter installation without room, simple installation, convenient operation, excellent performance, thereby reducing the construction cost. The filter is made according to Countries codes and standards.



TECHNICAL CHARACTERISTICS

Dimensions	950x580x800mm
Flow rate	15m ³ /h
Voltage	220V/50Hz or 60Hz
Precision of filtration bag	≤5μ
Operating noise	≤50Db
Material	Polyethylene
Installation	Wall mounted

EQUIPMENT

Filtration Pump	1x1.0 HP	
Filtration basket with bag	1pc	
Chlorine Feeder	1pc	
Light (Warm white)	1xLED	12W / 12V
Time controller	1pc	
Swim jet	2pcs	
Handle rail (S.S)	2pcs	
Ozone (optional)	1pc	Options

SYSTEM

Filtration system	1pc
Disinfection system	1pc
Time control system	1pc
Circle system	1pc
Lighting system	1pc

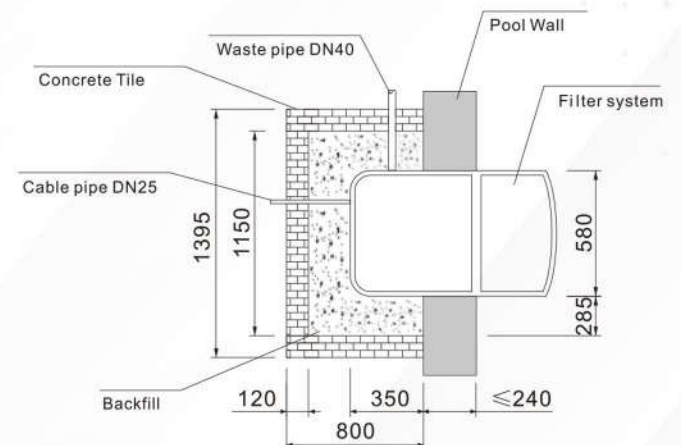
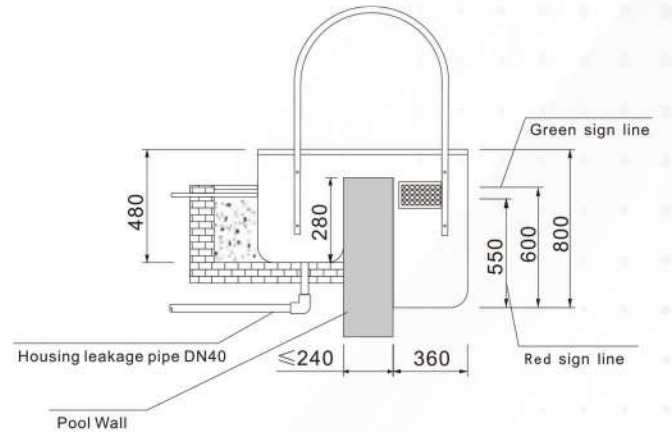



WALL-MOUNTED FILTER

Model : HPK8029 (Children Swimming Pool)

The enclosure of wall-mounted filter is made of high quality Polyethylene. The wall-mounted filter is change to traditional sand filter. Now the filter installation without room, simple installation, convenient operation, excellent performance, thereby reducing the construction cost. The filter is made according to Countries codes and standards.



TECHNICAL CHARACTERISTICS

Dimensions	1095x705x1230mm
Flow rate	25m ³ /h
Voltage	220V/50Hz or 60Hz
Precision of filtration bag	≤5μ
Operating noise	≤50Db
Material	Polyethylene
Installation	Wall mounted

EQUIPMENT

Filtration Pump	1x2HP	
Filtration basket with bag	1pc	
Chlorine Feeder	1pc	
Light (Warm white)	1xLED	12W / 12V
Time controller	1pc	
Swim jet	2pcs	
Handle rail (S.S)	2pcs	
Ozone (optional)	1pc	Options

SYSTEM

Filtration system	1pc
Disinfection system	1pc
Time control system	1pc
Circle system	1pc
Lighting system	1pc

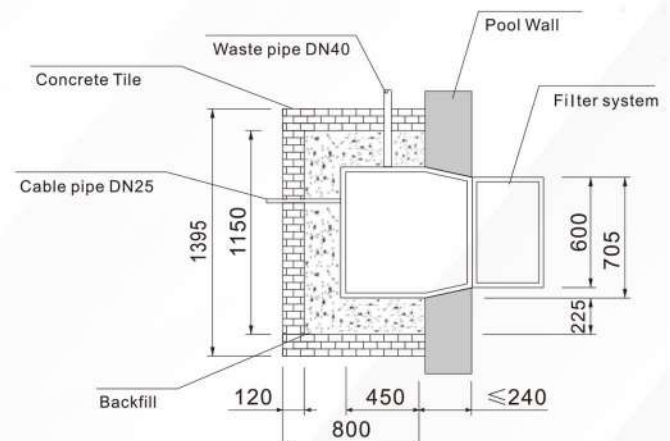
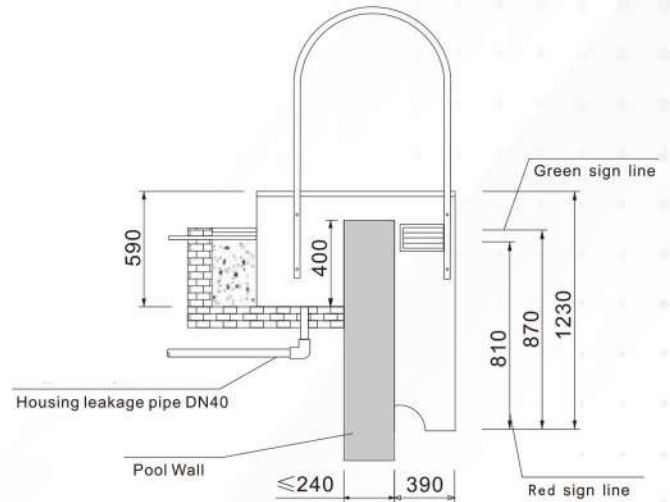



WALL-MOUNTED FILTER

Model : HPK8032

The enclosure of wall-mounted filter is made of high quality Polyethylene. The wall-mounted filter is change to traditional sand filter. Now the filter installation without room, simple installation, convenient operation, excellent performance, thereby reducing the construction cost. The filter is made according to Countries codes and standards.



TECHNICAL CHARACTERISTICS

Dimensions	1090x600x960mm
Flow rate	25m ³ /h
Voltage	220V/50Hz or 60Hz
Precision of filtration bag	≤5μ
Operating noise	≤50Db
Material	Polyethylene
Installation	Wall mounted

EQUIPMENT

Filtration Pump	1x2HP	
Filtration basket with bag	1pc	
Light (Warm white)	1xLED	12W / 12V
Time controller	1pc	
Swim jet	2pcs	
Ozone (optional)	1pc	Options

SYSTEM

Filtration system	1pc
Disinfection system	1pc
Time control system	1pc
Circle system	1pc
Lighting system	1pc

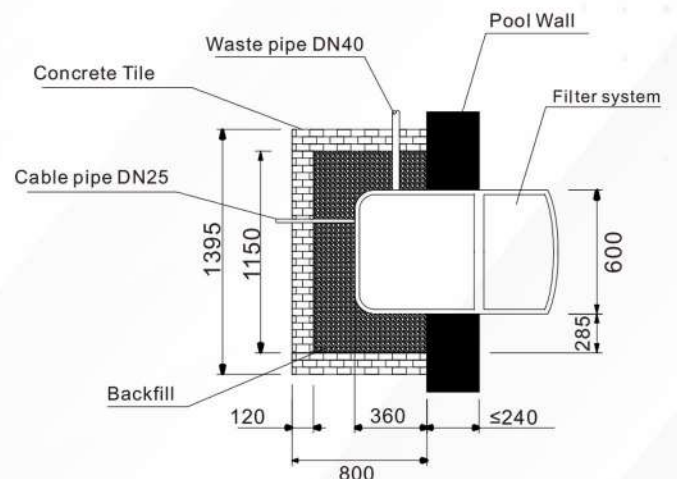
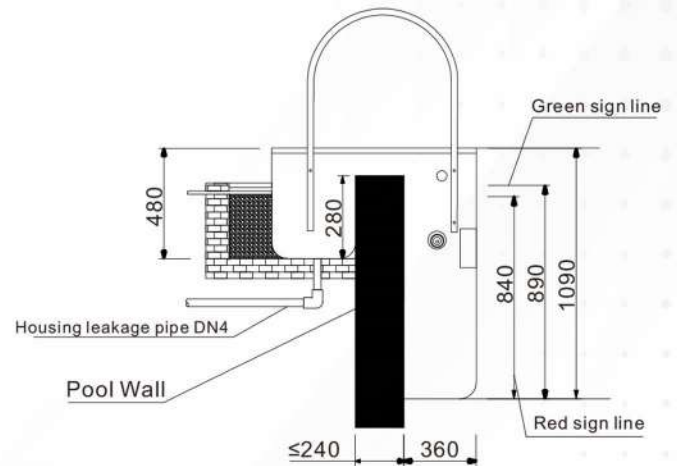

INGROUND FILTER





QUARTS SAND FILTER

Model : HPK8017

The enclosure of inground filter is made of high quality fiberglass and polyvinyl chloride, which is strong and durable, rust-proof, low temperature resistance and anti-uv light, etc. Equipped with filtering timing automatic control system and the automatic drainage system; Easy to install, no need a special machine room.

Notes: Massage pump, salt chlorinator and automatic chlorine off-line feeder(Optional)

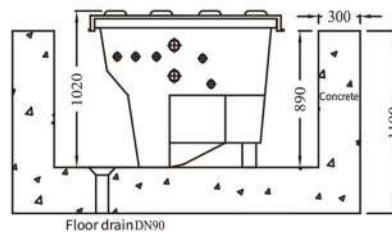
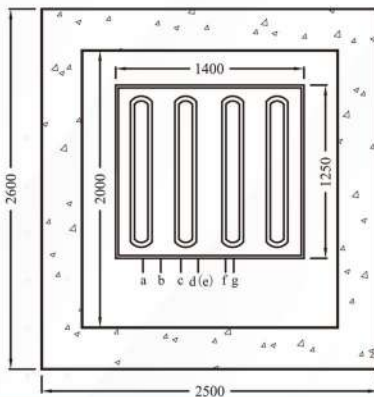

- | | |
|---|--|
| a | Connect backwater inlet $\Phi 50$ |
| b | Connect vacuum suction $\Phi 50$ |
| c | Connect skimmer $\Phi 50$ |
| d | Connect the outlet of the massage pump $\Phi 63$ |
| e | Connect the inlet of the massage pump $\Phi 63$ |
| f | Connect the water outlet $\Phi 50$ |
| g | Connect the sewage outlet $\Phi 50$ |

TECHNICAL CHARACTERISTICS

Power	1HP/220V	1.5HP/220V
Filter type	Sand filter $\Phi 525\text{mm}$ / $\Phi 625\text{mm}$	
Flow rate	12m ³ /h	16m ³ /h
External Dimension	1400x1250x1020mm	
Disinfection	Sterilizer	
Water pump	120w/220v	
Salt chlorinator	16~42 g/h	Options
Massage pump	3HP/220V	Options
UV	65w/220v	Options
CCOREL.250		Options

- Complete filtration
- Complete circulation
- Dose sterilization
- Circulating water pump
- Massage pump
- Pressure relief valve
- Pressure display
- 6-multi-port valve
- Automatic doser
- Time controller
- Contactor





QUARTS SAND FILTER

Model : HPK8018

The enclosure of inground filter is made of high quality fiberglass and polyvinyl chloride, which is strong and durable, rust-proof, low temperature resistance and anti-uv light, etc. Equipped with filtering timing automatic control system and the automatic drainage system; Easy to install, no need a special machine room.

Notes: Massage pump, salt chlorinator and automatic chlorine off-line feeder(Optional)

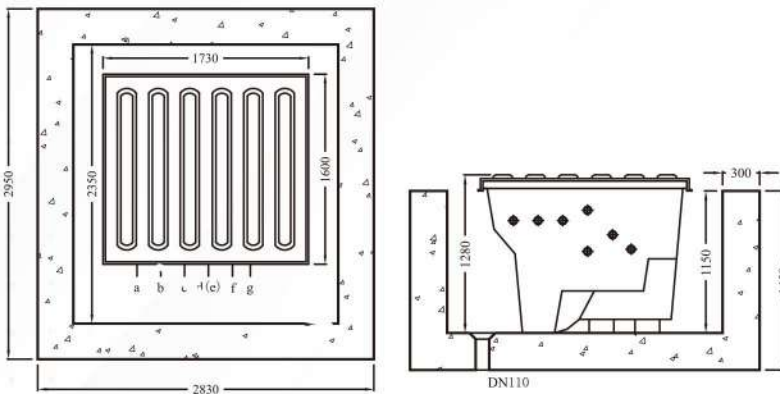

a	Connect backwater inlet $\Phi 50$
b	Connect vacuum suction $\Phi 50$
c	Connect skimmer $\Phi 50$
d	Connect the outlet of the massage pump $\Phi 63$
e	Connect the inlet of the massage pump $\Phi 63$
f	Connect the water outlet $\Phi 50$
g	Connect the sewage outlet $\Phi 50$

TECHNICAL CHARACTERISTICS

Power	2HP/220V	3HP/220V
Filter type	Sand filter $\Phi 800\text{mm}$ / $\Phi 900\text{mm}$	
Flow rate	25m ³ /h	31m ³ /h
External Dimension	1730x1600x1280mm	
Disinfection	Sterilizer	
Water pump	120w/220v	
Salt chlorinator	16~42 g/h	Options
Massage pump	3HP/220V	Options
UV	85w/220v	Options
CCOREL.250		Options

- Complete filtration
- Complete circulation
- Dose sterilization
- Circulating water pump
- Massage pump
- Pressure relief valve
- Pressure display
- 6-multi-port valve
- Automatic doser
- Time controller
- Contactora





QUARTS SAND FILTER

Model : HPK8010

In-ground filter are made of fiberglass and polyvinyl chloride, which is design and good-looking and durable. The in- ground does not need a machine house, which save construction cost, convenient operation and save maintenance cost. Multic use in-ground sand filter assemble complete set filtration configuration to high filtering capacity and to reach to back wash. According with swimming pool specifications and standards.

NOTES: Ozone and heater(optional)

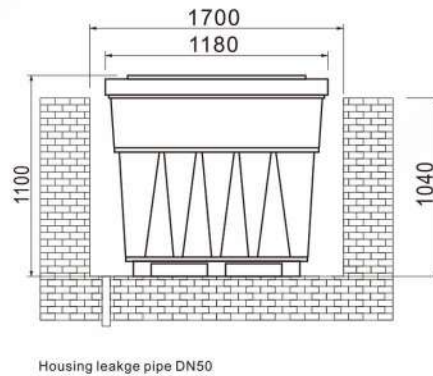
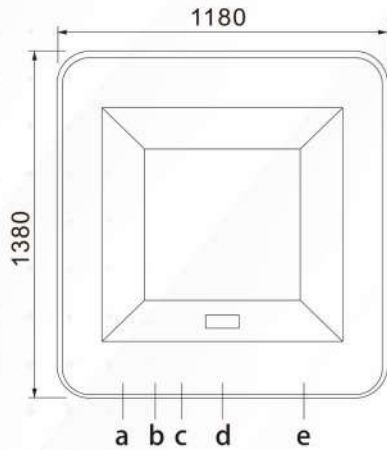

a	Connected wall return
b	Connected skimmer
c	Connected suction fitting
d	Connected wall return
e	Connected backwash

- Complete filtration
- Complete circulation
- Dose sterilization
- Circulating water pump
- Pressure relief valve
- Pressure display
- 6-multi-port valve
- Automatic doser
- Time controller
- Contactor

TECHNICAL CHARACTERISTICS

Power	1.5HP/220V	2.0HP/220V
Filter type	Sand filter Φ 625mm / Φ 700mm	
Flow rate	16m ³ /h	21m ³ /h
External Dimension	1380x1180x1100mm	
Disinfection	Sterilizer	





QUARTS SAND FILTER

Model : HPK8011

In-ground filter are made of fiberglass and polyvinyl chloride, which reasonable design and good-looking and durable. The inground does not need a machine house, which save construction cost, convenient operation and save maintenance cost. Multic use in-ground sand filter assemble complete set filtration configuration to high filtering capacity and to reach to back wash. According with swimming pool specifications and standards, it's the best choice for Big and commercail swimming pools.

NOTES: Ozone and heater (optional).

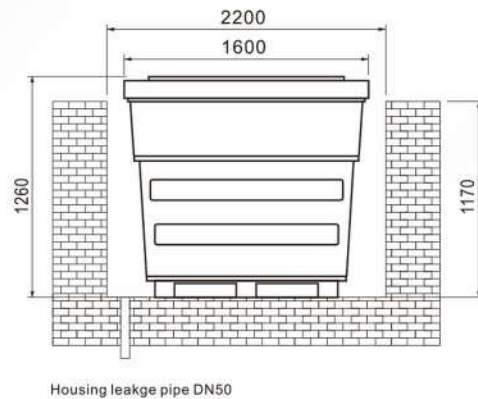
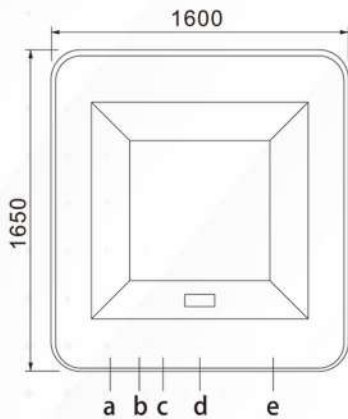

a	Connected wall return
b	Connected skimmer
c	Connected suction fitting
d	Connected wall return
e	Connected backwash

- Complete filtration
- Complete circulation
- Dose sterilization
- Circulating water pump
- Pressure relief valve
- Pressure display
- 6-multi-port valve
- Automatic doser
- Time controller
- Contactora

TECHNICAL CHARACTERISTICS

Power	2HP/220V	3HP/220V	
Filter type	Sand filter	Φ800mm	Φ900mm Φ1000mm
Flow rate	26m ³ /h	33m ³ /h	40.5m ³ /h
External Dimension	1650x1600x1260mm		
Disinfection	Sterilizer		





QUARTS SAND FILTER

Model : HPK8012

In-ground filter are made of fiberglass and polyvinyl chloride, which reasonable design and good-looking and durable. The inground does not need a machine house, which save construction cost, convenient operation and save maintenance cost. Multic use in-ground polyester fiber filter assemble complete set filtration configuration to high filtering capacity. According with swimming pool specifications and standards.

NOTES: Ozone and heater(optional).

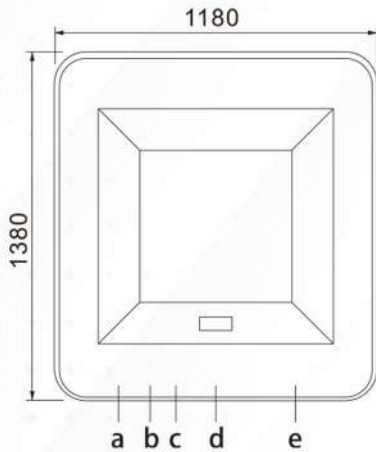

a	Connected wall return
b	Connected skimmer
c	Connected suction fitting
d	Connected wall return

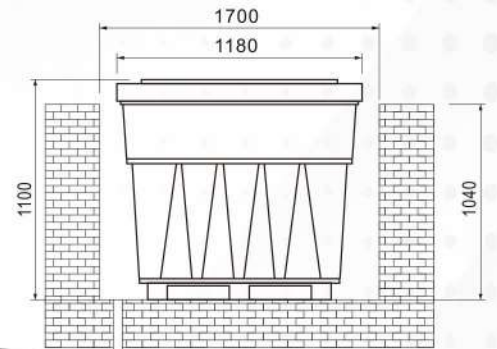

Housing leakage pipe DN50

TECHNICAL CHARACTERISTICS

Power	3HP/220V
Filter type	Polyester Fiber 2x75ft ²
Filter Capacity	36m ³ /h
External Dimension	1380x1180x1200mm
Disinfection	Sterilizer



GL-002
(Time control box)





QUARTS SAND FILTER

Model : HPK8019

The enclosure of wall-mounted filter is made of high quality Acrylic and fiberglass, so the filter is anti-acid anti-fading, and easy to clean. Integrated filter installation without room, simple installation, convenient operation, excellent performance, thereby reducing the construction cost. It's big flow rate for 8pcs filter bag.

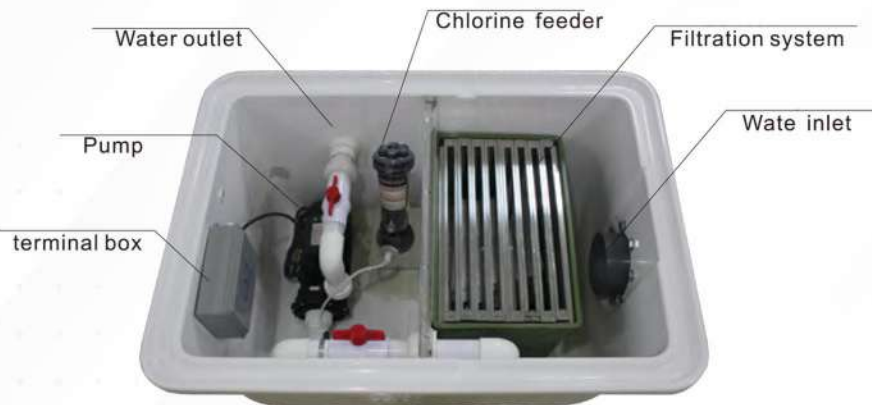

TECHNICAL CHARACTERISTICS

Dimensions	1370x1000x720mm
Flow rate	47m ³ /h
Voltage	220V/50Hz or 60Hz
Precision of filtration bag	≤5μ
Operating noise	≤50Db
Material	Fiberglass/Acrylic
Installation	Inground

EQUIPMENT

Filtration Pump	1x4HP
Filtration basket with bag	8pcs
Chlorine feeder	1pc
Time controller	1pc
4" Connection Inlet	1pc

SYSTEM

Filtration system	1pc
Disinfection system	1pc
Time control system	1pc
Circle system	1pc

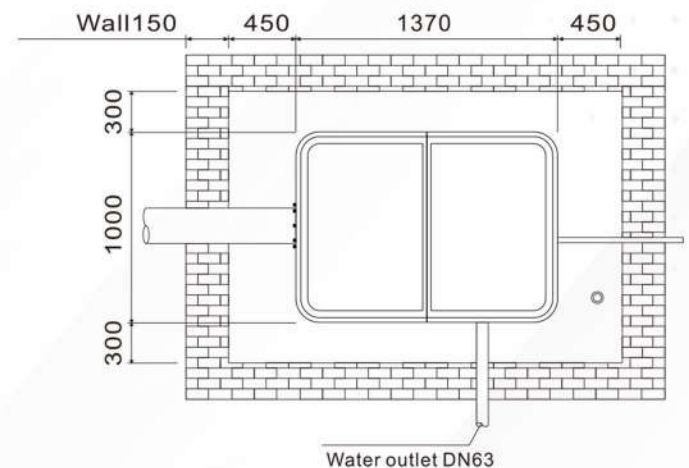
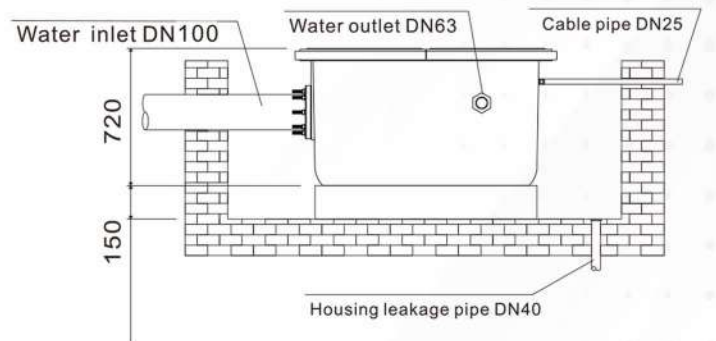



QUARTS SAND FILTER

Model : HPK8015

The enclosure is made of high quality fiberglass and Acrylic, which is strong and durable, rust-proof, low temperature resistance and anti-UV light, etc. Equipped with filtering timing automatic control system and the automatic drainage system; easy to install, no need a special machine room.

Notes: Massage pump, salt chlorinator and automatic chlorine off-line feeder(Optional).



1	Filter shell
2	Sand filter
3	Junction box
4	Water quality controller
5	Chlorinator feeder
6	Submersible pump
7	UV sterilizer
8	Water pump

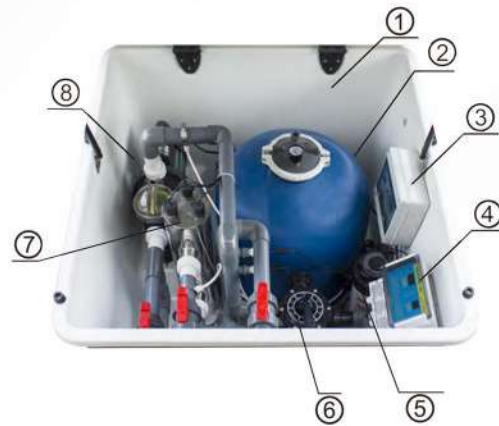

a	Connect the water return, suction fitting
b	Connect the water outlet (after the water disinfection)
c	Connect the water outlet (after the UV)
d	Connect the water outlet (after the Submersible pump)
e	Connect the water outlet (sand filter)

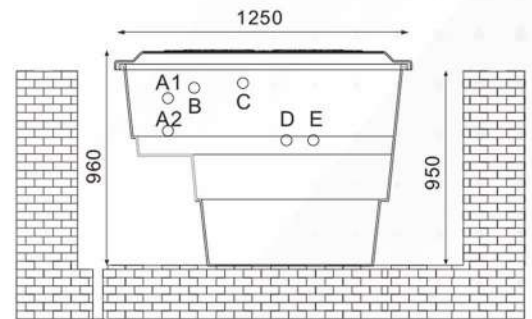

TECHNICAL CHARACTERISTICS

Power	1HP/220V	1.5HP/220V
Filter type	Sand filter Φ 525mm Φ 625mm	
Flow rate	12m ³ /h	16m ³ /h
External Dimension	1300x1250x960mm	
Disinfection	Sterilizer	
Water pump	120W/220V	
Salt chlorinator	16~42 g/h	(options)
UV	65W/220V	(options)
CCOREI		(options)

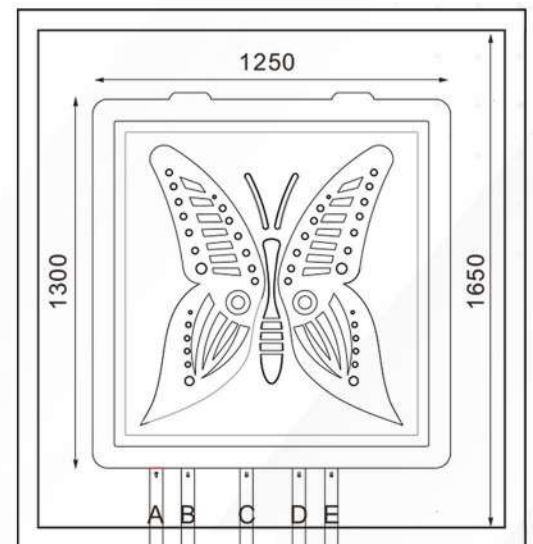



QUARTS SAND FILTER

Model : HPK8016

The enclosure is made of high quality fiberglass and Acrylic, which is strong and durable, rust-proof, low temperature resistance and anti-UV light, etc. Equipped with filtering timing automatic control system and the automatic drainage system; easy to install, no need a special machine room.

Notes: Massage pump, salt chlorinator and automatic chlorine off-line feeder (Optional).

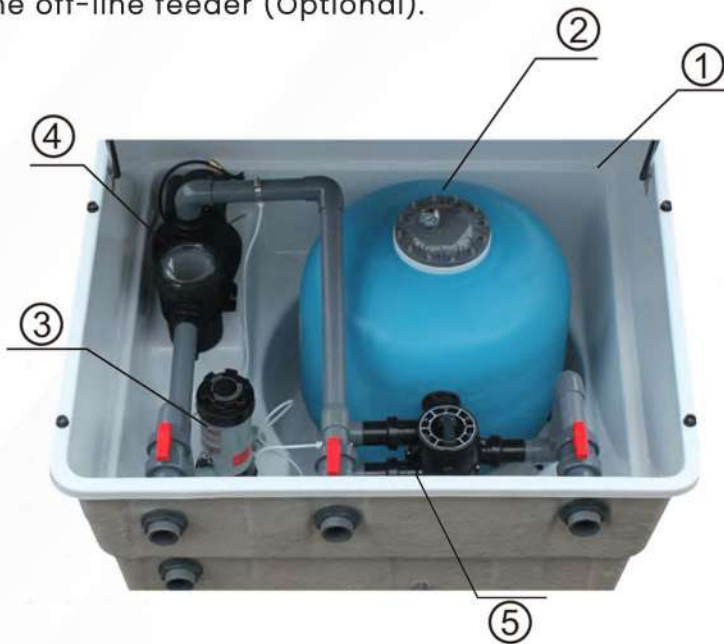

1	Filter shell
2	Sand filter
3	Chlorinator feeder
4	Water pump
5	Submersible pump

a	Connect the water return, suction fitting
b	Connect the water outlet (after the water disinfection)
c	Connect the water outlet (after the UV)
d	Connect the water outlet (after the Submersible pump)
e	Connect the water outlet (sand filter)

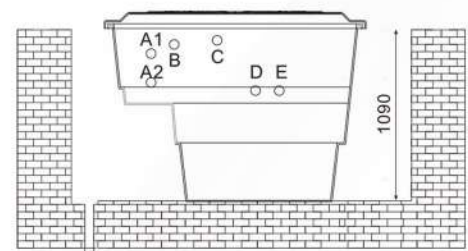

TECHNICAL CHARACTERISTICS

Power	2HP/220V	3HP/220V
Filter type	Sand filter Φ 800mm Φ 900mm	
Flow rate	25m ³ /h	31m ³ /h
External Dimension	1650x1700x1250mm	
Disinfection	Sterilizer	
Water pump	120W/220V	
Salt chlorinator	16~42 g/h	(options)
UV	85W/220V	(options)
CCOREI		(options)

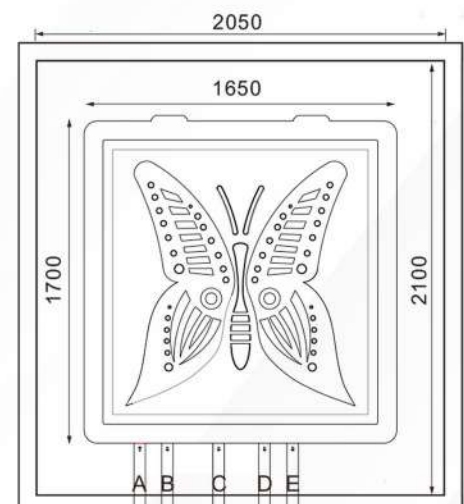



QUARTS SAND FILTER

Model : HPK8013

The enclosure is made of high quality fiberglass and Acrylic, which is strong and durable, rust-proof, low temperature resistance and anti-UV light, etc. Equipped with filtering timing automatic control system and the automatic drainage system; easy to install, no need a special machine room.

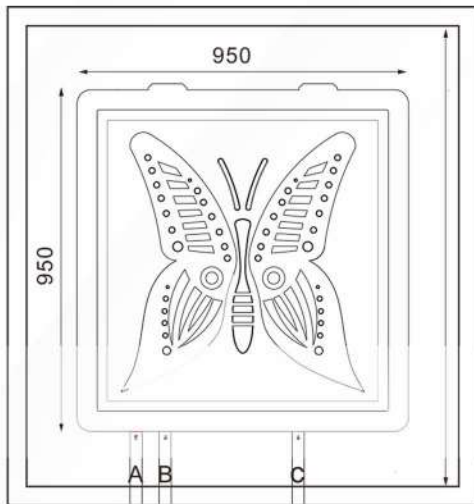

- a Connect backwater inlet $\Phi 50$
- b Connect the water outlet $\Phi 50$
- c Connect the sewage outlet $\Phi 50$

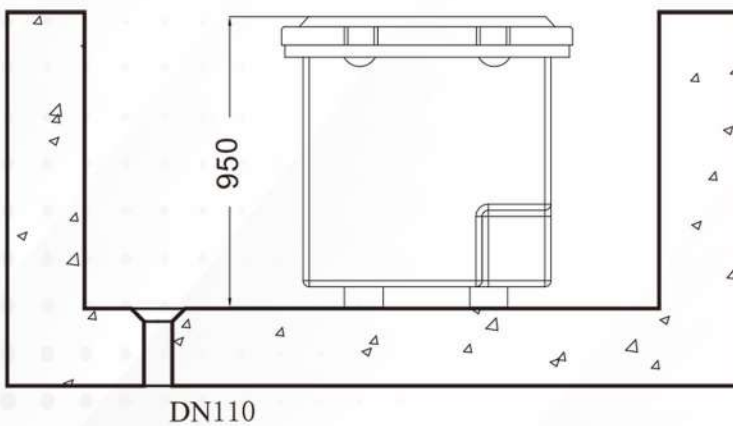

- Complete filtration
- Complete circulation
- Dose sterilization
- Circulating water pump
- Massage pump
- Pressure relief valve
- Pressure display
- 6-multi-port valve
- Automatic doser
- Time controller
- Contactator

TECHNICAL CHARACTERISTICS

Power	0.5 HP/220V	0.75HP	3HP/220V
Filter type	Sand filter $\Phi 400\text{mm}$ $\Phi 450\text{mm}$ $\Phi 525\text{mm}$		
Flow rate	8m ³ /h	10m ³ /h	12m ³ /h
External Dimension	950x950x950mm		
Water pump	120W/220V	Options	
Disinfection	Sterilizer		



QUARTS SAND FILTER

Model : HPK8027

The enclosure is made of high quality fiberglass and Acrylic, which is strong and durable, rust-proof, low temperature resistance and anti-UV light, etc. Equipped with filtering timing automatic control system and the automatic drainage system; easy to install, no need a special machine room. Equipped with cartridge filter inside the box, easy to operate.

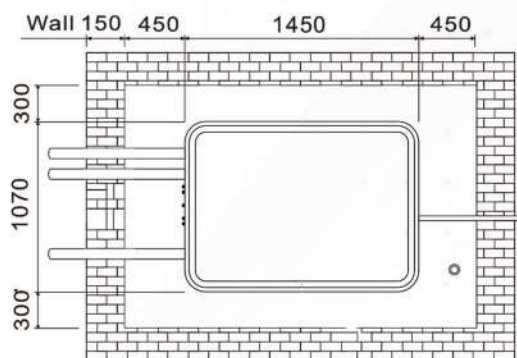
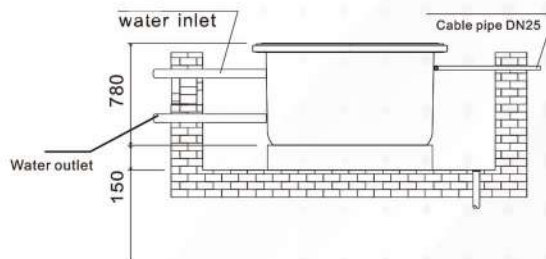

1	Filter shell
2	Cartridge filtration
3	Chlorinator feeder
4	Water pump

a	Connect the water return
b	Connect the water return
c	Connect the water outlet
d	Connect the water outlet (cartridge filtration)

TECHNICAL CHARACTERISTICS

Power	3.0 HP/220V	
Filter type	Cartridge filtration AF50x3pc	
Flow rate	42m ³ /h	
External Dimension	1450x1070x780	
Disinfection	Sterilizer	
Water pump	120W/220	Options



QUARTS SAND FILTER

Model : HPK8035A



- a Connect the water return, suction fitting
- d Connect the circulation outlet
- e Connected backwash

Power	0.75 HP/220V	1.0HP/220V
Filter type	Sand filter Ø525mm	
Flow rate	10m ³ /h	12m ³ /h
External Dimension	1150x1100x810mm	
Chlorine feeder	CL-100	1pc
Time Controller	1pc	

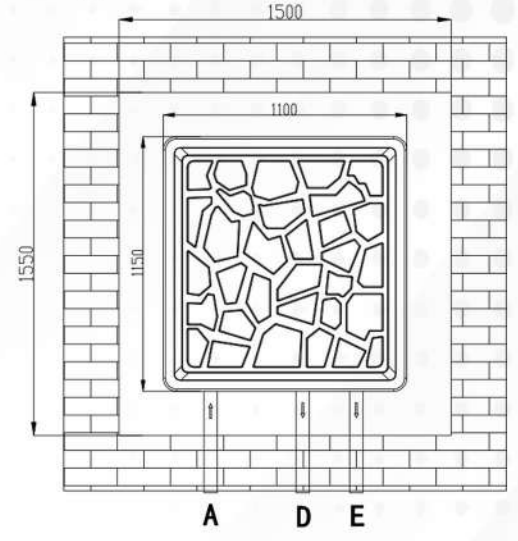
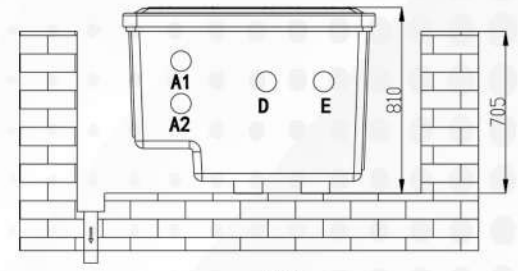

Model : HPK8035B



- a Connect the water return, suction fitting
- d Connect the circulation outlet
- e Connected backwash

Power	1.0 HP/220V	1.5HP/220V
Filter type	Sand filter Ø525mm / Ø650mm	
Flow rate	12m ³ /h	16m ³ /h
External Dimension	1150x1100x900mm	
Chlorine feeder	CL-100	1pc
Time Controller	1pc	

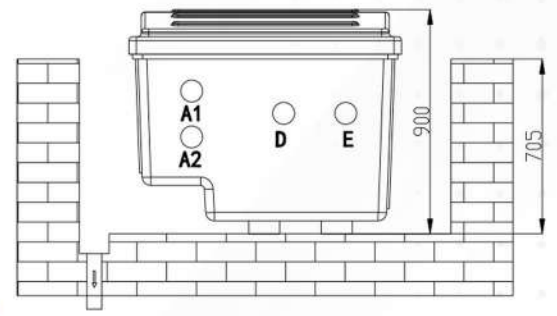



POOL MASSAGE

Model : HPK8031



HPK-8031A

TECHNICAL CHARACTERISTICS

Model No.	HPK8031 (Pool massage)
Material	(Acrylic)
Dimension	2600(L) x 1600(W) x 1200(H)mm
Weight	-
Color	(bone color)
Power	220V/50Hz
Flow rate	25m ³ /h
Hydrotherapy system	- 26 massage nozzles (Jet), 30 bubble massage nozzles (Airjet), stainless steel nozzle set (s, s jet) - 2 circulating water supply ports (Circulating) and 1 countercurrent swimming nozzle (Swim jet)
Filtering system	1. 2 filter barrels (1 for 5 microns/1 for 15 microns) (Filter bag) 2. 2 water outlets (Water return) 3. Sinking separate waterproof equipment box (1200x1000x500mm) (Water proof box)
Treatment	Ozone generator (500mg/h, 132W) (Ozone)
Lighting	Swimming pool underwater lights (LED 18W/12V) (Light)
Control panel	1. Fully automatic digital controller (digital clock/water temperature display) (Digital controller) options 2. Massage water flow adjustment knob (Flow control valve) options 3. Air/water mixing ratio adjustment knob (Air control valve) options
HPK-8031A Pumps	- Filter water pump (1pcs/2HP) (Filtration pump) options - Massage pumps (2pcsx3HP) (Massage pump) Option - Air pump (1pcs/900W) (Air blower) options
Approval	Ce certification





HORBO SAND FILTER SERIES





"HP" SERIES FIBERGLASS TOP MOUNT FILTER

Bobbin-wound fiberglass reinforced tank is still the most popular standard in the industry after all. With UV-resistant surface finished, it is able to operate under prolonged sunlight for years of reliability. HP series (HP400-HP1400) filters are equipped with a six-position, clamp and screw styles multiport valve and ABS laterals.



HP400-700



HPQ400-700

Highlight Features

- Max operating pressure 36psi/2.5bar
- Max temperature of 43°C (109°F)
- Universal standard of union connection provided
- Suggested size of media: 0.5-1.2mm

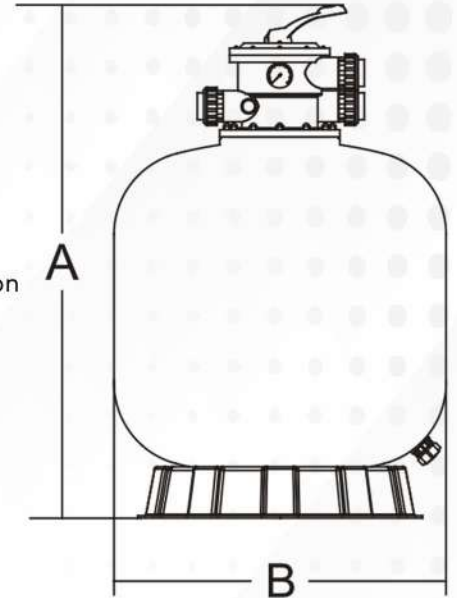

TECHNICAL CHARACTERISTICS

Model	Filter Area (m ²)	Valve Connecting		Max Flow Rate	Gravel (Kg)	A mm	B mm
HP400	0.13	1.5 inch	50 mm	8 m ³ /h	35	760	400
HP450	0.16	1.5 inch	50 mm	10 m ³ /h	45	815	450
HP525	0.22	1.5 inch	50 mm	12 m ³ /h	85	880	525
HP625	0.30	1.5 inch	50 mm	16 m ³ /h	150	1005	625
HP700	0.40	1.5 inch	50 mm	20 m ³ /h	210	1100	700
HP700B	0.40	2.0 inch	63 mm	21 m ³ /h	215	1150	700
HP750	0.45	2.0 inch	63 mm	23 m ³ /h	300	1180	750
HP800	0.50	2.0 inch	63 mm	25 m ³ /h	355	1310	800
HP900	0.64	2.0 inch	63 mm	31 m ³ /h	470	1380	900
HP1000	0.79	2.0 inch	63 mm	36 m ³ /h	620	1495	1000
HP1100	0.96	2.0 inch	63 mm	42 m ³ /h	800	1580	1100
HP1200	1.13	2.0 inch	63 mm	45 m ³ /h	900	1600	1200
HP1400	1.54	2.0 inch	63 mm	56 m ³ /h	1350	1810	1400



HP750-1400

Functions : 6-Way Multiport Valve

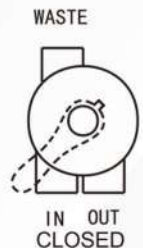
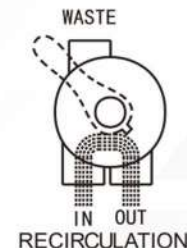
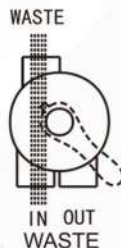
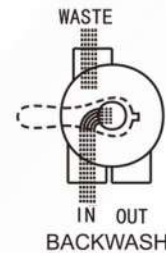
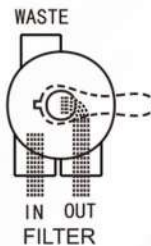



"HSL" SERIES FIBERGLASS SIDE MOUNT DEEP BED FILTER

HSL Series Side Mount Deep Bed Filter offers a more thorough filtration with the standard of either 1mm or 1.2mm deep sand bed which is suitable for high filtration performance of domestic swimming pool



Lateral system



Manhole

Highlight Features

- Max operating pressure 36psi/2.5bar
- Max temperature of 43°C (109°F)
- Maximum filtration velocity : 50m³ /h/m³
- Universal standard of union connection provided
- Suggested size of media : 0.5-1.2mm
- Dual layers of laterals
- 4" Sight glass
- 158mm manhole for servicing
- 2" bottom drain

TECHNICAL CHARACTERISTICS

Model	Filter Area (m ²)	Valve Connecting		Max Flow Rate		Gravel (Kg)
HSL700-1.0	0.38	1.5 inch	63mm	253lpm	15.20m ³ /h	580
HSL700-1.2	0.38	1.5 inch	63mm	253lpm	15.20m ³ /h	696
HSL800-1.0	0.50	2.0 inch	63mm	333lpm	20.00m ³ /h	769
HSL800-1.2	0.50	2.0 inch	63mm	333lpm	20.00m ³ /h	914
HSL900-1.0	0.63	2.0 inch	63mm	420lpm	25.2m ³ /h	957
HSL900-1.2	0.63	2.0 inch	63mm	420lpm	25.2m ³ /h	1146
HSL1000-1.0	0.78	2.0 inch	63mm	520lpm	31.20m ³ /h	1204
HSL1000-1.2	0.78	2.0 inch	63mm	520lpm	31.20m ³ /h	1436

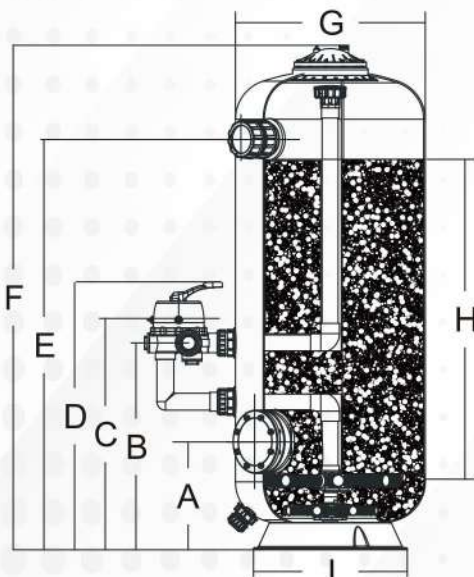

Model	A mm	B mm	C mm	D mm	E mm	F mm	G mm	H mm	I mm
HSL700-1.0	388	758	844	987	1320	1672	700	1000	576
HSL700-1.2	388	758	844	987	1520	1872	700	1200	576
HSL800-1.0	422	752	838	981	1313	1702	800	1000	800
HSL800-1.2	422	752	838	981	1513	1902	800	1200	800
HSL900-1.0	441	771	857	1000	1331	1735	900	1000	800
HSL900-1.2	441	771	857	1000	1531	1935	900	1200	800
HSL1000-1.0	515	885	971	1114	1406	1813	1000	1000	995
HSL1000-1.2	600	970	971	1199	1560	2013	1000	1200	995

Note : Suggested sand weight varies with differences in filter media size, For reference only



"HPS" SERIES FIBERGLASS SIDE MOUNT FILTER

Bobbin-wound fiberglass reinforced tank is still the most popular standard in the industry after all. With UV-resistant surface finished, it is able to operate under prolong sunlight for years of reliability. "Hps" series filters are equipped with a six position, clamp and screw styles mulport vale and ABS laterals.



HPS525-700

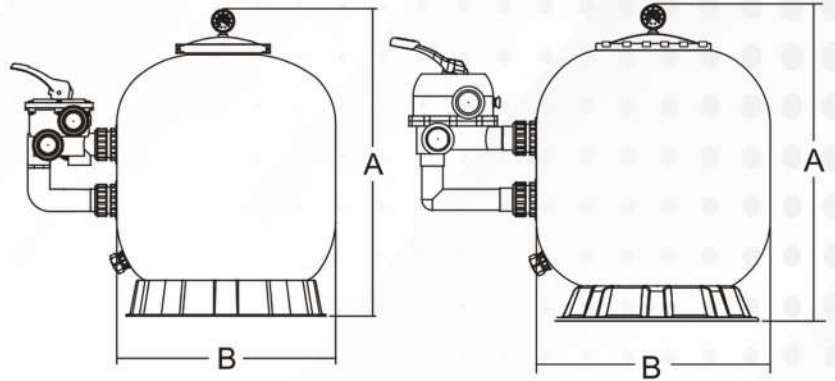

Highlight Features

- Max operating pressure 36psi/2.5bar
- Max temperature of 43°C (109°F)
- Universal standard of union connection provided
- Suggested size of media : 0.5-1.2mm



HP750-1400

TECHNICAL CHARACTERISTICS

Model	Filter Area (m ²)	Valve Connecting	Max Flow Rate	Gravel (Kg)	A mm	B mm
HPS525	0.22	1.5 inch 50mm	12m ³ /h	85	780	525
HPS625	0.30	1.5 inch 50mm	16m ³ /h	150	880	625
HPS700	0.40	1.5 inch 50mm	20m ³ /h	210	945	700
HPS700B	0.40	2.0 inch 63mm	21m ³ /h	215	945	700
HPS750	0.45	2.0 inch 63mm	23m ³ /h	300	960	750
HPS800	0.50	2.0 inch 63mm	25m ³ /h	355	1080	800
HPS900	0.64	2.0 inch 63mm	31m ³ /h	470	1100	900
HPS1000	0.79	2.0 inch 63mm	36m ³ /h	620	1285	1000
HPS1100	0.96	2.0 inch 63mm	42m ³ /h	800	1380	1100
HPS1200	1.13	2.0 inch 63mm	45m ³ /h	900	1500	1200
HPS1400	1.54	2.0 inch 63mm	56m ³ /h	1350	1580	1400

Note : Reference Only





"HPL" SERIES FIBERGLASS SIDE MOUNT FILTER

HPL Series Commercial Sand Filter satisfies the demand of different water treatment including pools installed within-floor cleaning systems spa, fountains and public swimming pool.



HPL 1200-2350

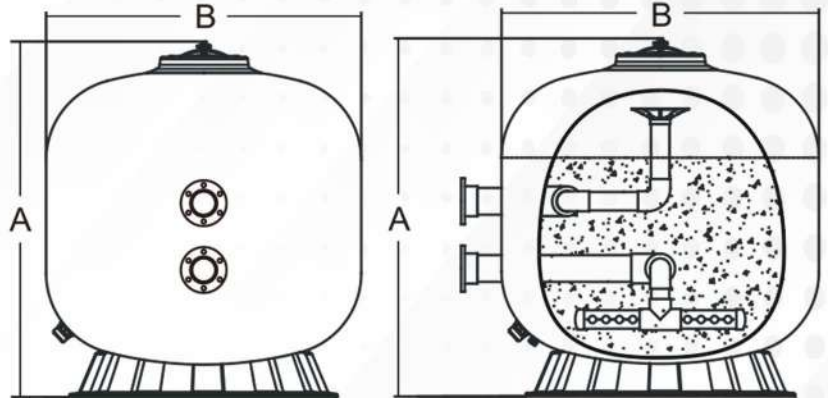

Highlight Features

- Max operating pressure 36psi/2.5bar
- Max temperature of 43°C (109°F)
- Universal standard of union connection provided
- Suggested size of media : 0.5-1.2mm



water inlet

water outlet

TECHNICAL CHARACTERISTICS

Model	Filter Area (m ²)	Valve Connections		Max Flow Rate	Gravel (Kg)	A mm	B mm
HPL1200	1.13	3.0 inch	90mm	55m ³ /h	900	1410	1200
HPL1400	1.54	3.0 inch	90mm	76m ³ /h	1350	1570	1400
HPL1600	2.06	4.0 inch	110mm	100m ³ /h	2300	1740	1600
HPL1800	2.52	6.0 inch	160mm	120m ³ /h	2900	2040	1800
HPL2000	2.97	6.0 inch	160mm	145m ³ /h	4000	2210	2000
HPL2300	4.43	8.0 inch	200mm	210m ³ /h	6000	2510	2300
HPL2350	4.43	8.0 inch	200mm	210m ³ /h	6000	2510	2350

4/5 Way Butterfly Valve



4 Way Butterfly Valve

250kPa/36psi/2.5bar
400kPa/58psi/4.0bar
43°C (109 °F)

Max operating pressure : 250kPa/36psi/2.5bar
Factory Testing Pressure : 400kPa/58psi/4.0bar
Maximum Water Temperature : 43°C (109 °F)



5 Way Butterfly Valve



"HFSB" SERIES FIBERGLASS COMBO

Designed for easy set-up domestic pool, "HFSB" Series filtration combo offers the right solution for home user who is looking for user-friendly and excellent filtration performance. HFSB Series Filtration Combo includes top mount fiberglass filter tank, 6-way muliport value, swimming pool pumps attached with base.

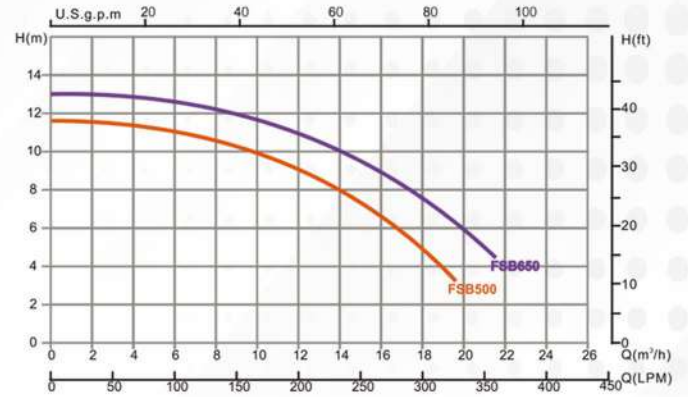

Highlight Features

- Max operating pressure 36psi/2.5bar
- Max temperature of 43°C (109°F)
- Universal standard of union connection provided
- Suggested size of media : 0.5-1.2mm

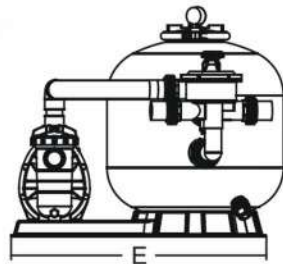
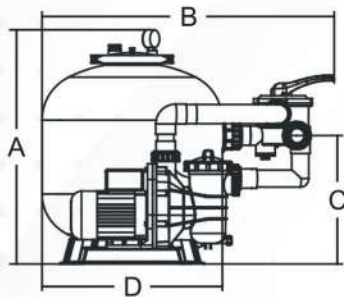

TECHNICAL CHARACTERISTICS

Model No	Filter	Pump	Valve Connections	Sand (Kg)
HFSB500-6W	PS525	STP100	1.5 Inch	85
HFSB650-6W	PS625	STP120	1.5 Inch	145

Model No	A mm	B mm	C mm	D mm	E mm	Max Flow Rate
HFSB500-6W	770	867	390	527	760	185lpm
HFSB650-6W	850	967	430	627	760	260lpm

"HPSF" SERIES FIBERGLASS COMBO

Designed for easy set-up domestic pool, "HPSF" Series filtration combo offers the right solution for home user who is looking for user-friendly and excellent filtration performance. HPSF Series Filtration Combo includes top mount fiberglass filter tank, 6-way muliport value, swimming pool pumps attached with base.



Highlight Features

- Max operating pressure 36psi/2.5bar
- Max temperature of 43°C (109°F)
- Universal standard of union connection provided
- Suggested size of media : 0.5-1.2mm



TECHNICAL CHARACTERISTICS

Model No	Max Flow Rate	Filter	Pump	Valve Connections	Sand (Kg)
HPSF400-6W	6.48	P400	STP50	1.5 Inch	35
HPSF450-6W	8.10	P450	STP75	1.5 Inch	45
HPSF525-6W	11.1	P525	STP100	1.5 Inch	85
HPSF625-6W	15.6	P625	STP120	1.5 Inch	150



STAINLESS STEEL FILTER SERIES



TOP-MOUNT SAND FILTER

Top-Mount Sand Filter

Model No	Tank Dia. mm	Hight mm	Pipe Size (inch)	Filter Area	Silca Sand	Flow (m ³ /h)	Pressure (Kg/cm ²)
HD400	400	800	1.5	0.13	70	6.7	2.5
HD500	500	870	1.5	0.22	100	10.8	2.5
HD600	600	970	1.5	0.36	170	16.4	2.5
HD700	700	1000	2.0	0.41	190	21.3	2.5
HD800	800	1160	2.0	0.51	300	26.8	2.5
HD900	900	1260	2.0	0.65	400	32.6	2.5
HD1000	1000	1270	2.0	0.81	500	40.3	2.5



SIDE-MOUNT SAND FILTER

Top-Mount Sand Filter

Model No	Tank Dia. mm	Hight mm	Pipe Size (inch)	Filter Area	Silca Sand	Flow (m ³ /h)	Pressure (Kg/cm ²)
HD1200	1200	1450	3	1.14	1100	55	2.5
HD1400	1400	1570	4	1.56	1900	76	2.5
HD1600	1600	1760	4	2.01	2300	100	2.5
HD1800	1800	2040	4	2.54	2900	129	2.5
HD2000	2000	2240	6	2.97	4600	147	2.5
HD2200	2200	2520	6	4.10	5800	218	2.5
HD2300	2300	2550	6	4.43	6000	220	2.5
HD2500	2500	2680	8	4.89	6700	240	2.5



TOP-MOUNT SAND FILTER

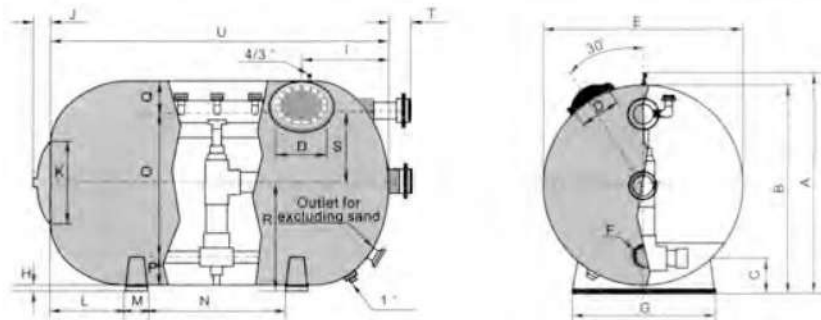

Top-Mount Sand Filter

Code	A	B	C	D	E	F	G	H	I	J	K	L	M	N	O	P	Q	R	S	T	U
040416	1800	1700	400	φ400	1600	φ160	1320	100	1050	120	φ500	480	260	870	990	250	360	900	440	100	2350
040418	2020	1920	400	φ400	1800	φ160	1480	100	1050	120	φ500	500	260	1080	1090	250	460	1000	440	100	2800
040420	2260	2160	600	φ400	2000	φ160	1640	120	1050	120	φ500	700	300	1100	1270	350	380	1120	550	160	3000
040424	2660	2560	600	φ400	2400	φ160	2300	120	1050	120	φ500	900	300	1480	1470	350	580	1320	550	160	3000
040425	2760	2660	600	φ400	2500	φ160	2300	120	1050	120	φ500	1050	300	1600	1520	350	630	1370	550	160	3000

CRYSTAL SAND FILTER MATERIAL



The paper core crystal sand filter material can effectively reduce the frequency of electric backwashing and save the number of water use; it has more advantages than quartz sand. Higher wear resistance, longer service life, not easy to break. No biofilm will be formed, and the surface area is 300 times larger than that of sand; suitable for it is used for filtration of gymnasium swimming pools, dedicated to marine aquariums, private villa swimming pools, and children's water parks.

Technical Characteristics	
Size mm	Weight (Kg/bag)
0.5-0.8	25
1.0-2.0	25
3.0-4.0	25



CARTRIDGE FILTER

Cartridge filtration is an effective trouble-free proven method of filtration. Pool water enters the filter and passes through a polyester single element cartridge. Suspended particles are trapped and the water is returned to the pool. As the build-up of dirt in the element increases, so the water pressure rises and the flow decreases. When the pressure reaches an unacceptable level the element must be removed and cleaned.



Cleaning brush

HAF PAPER

Model	Core diameter (mm)	Caliber (mm)	High (cm)	Filter material	Filtration accuracy (µm)
HAF25	Φ183	Φ78	18.45	White precision polyester fiber fabric	≤15
HAF50	Φ183	Φ78	36.45		
HAF75	Φ183	Φ78	54.45		
HAF100	Φ183	Φ78	72.45		
HAF150	Φ183	Φ78	90.45		

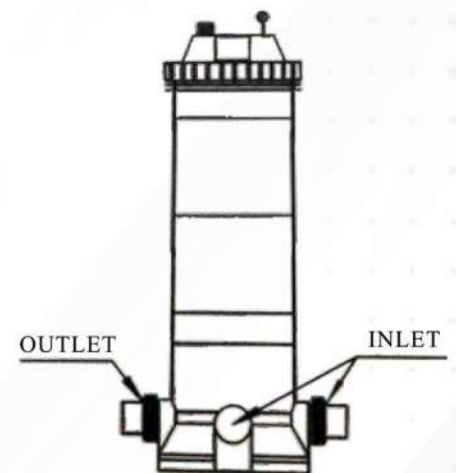

HAF PAPER FILTER

Technical Characteristics

Model	diameter (mm)	Height (mm)	Pump selection range (w)	Filter area (m ²)	Flow (m ³ /h)	Greatest pressure (kpa)	Long cm	Width cm	High cm	Weight kg
HAF25	225	387	250-370	2.3	7.0	350	32	32	51	5.85
HAF50	225	567	550-750	4.7	14.0	350	32	32	69	7.35
HAF75	225	747	750-1100	7.0	17.0	350	32	32	86	9.05
HAF100	225	927	1100-1500	9.4	22.9	350	32	32	104.5	10.8
HAF150	225	1107	1100-2200	14.0	33.4	350	32	32	122	12.6

PUMP SERIES





NEW "HPB" SERIES PUMP

NEW "HPB" series heavy duty pump delivers high flow and energy efficiency ultra performance. It is suitable for commercial swimming pool 2 inch suction. Ring lock seal design to eliminate suction leaks and to maximize suction efficiency.

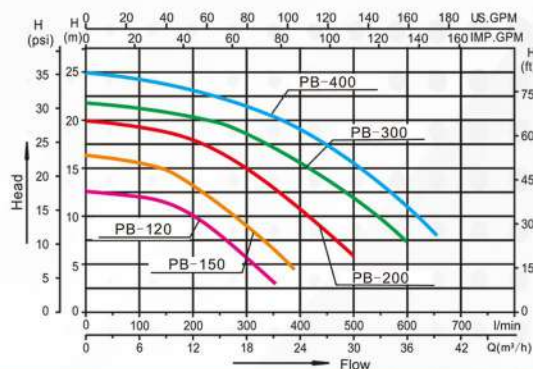

OVERALL DIMENSION

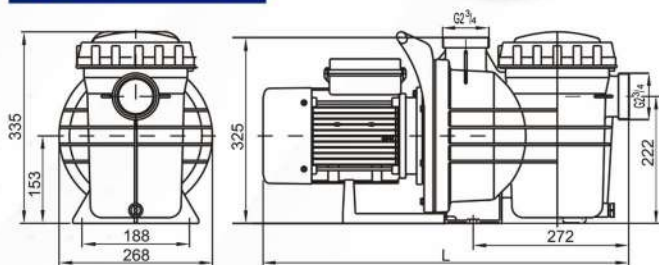

TECHNICAL CHARACTERISTICS

New Model	Power (p ₁)		QMax (l/min)	HMax (m)	V	Packaging Size (mm)
	KW	HP				
HPB-120	0.9	1.2	350	12.5	220	675x315x420
HPB-150	1.1	1.5	380	16.5	220	675x315x420
HPB-200	1.5	2.0	500	20	220	675x315x420
HPB-300	2.2	3.0	600	22	200	675x315x420
HPB-300	2.2	3.0	600	22	380	675x315x420
HPB-400	3.0	4.0	650	25	380	700x315x420

NEW "HPC" SERIES PUMP

NEW "HPC" series swimming pool pump is designed for medium head installation in medium or domestic pool. 1.5 inch suction and discharge port with transparent lid. It operates at a low decibel and easy maintenance.

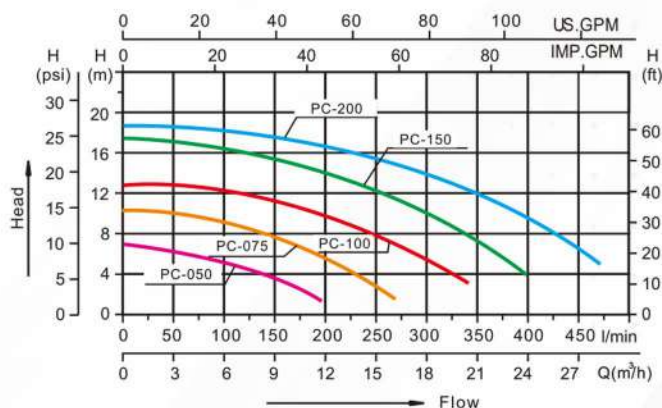

OVERALL DIMENSION

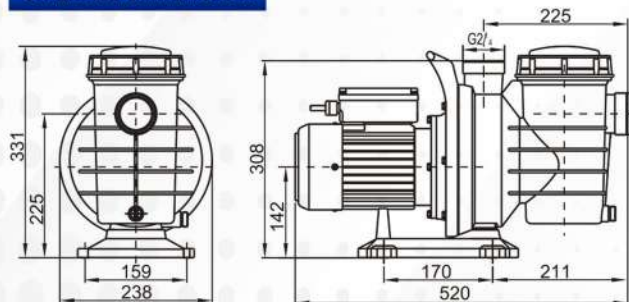

TECHNICAL CHARACTERISTICS

New Model	QMax (l/min)	HMax (m)	V/Hz	Power (p ₁)		Amps	Fitting Size	Kg
				Kw	Hp			
HPC-050	195	7	220-240/50	0.37	0.50	1.9	48.5 Or 50	9.3
HPC-075	255	10	220-240/50	0.55	0.75	2.7	48.5 Or 50	9.5
HPC-100	340	12.5	220-240/50	0.75	1.0	3.8	48.5 Or 50	9.7
HPC-150	390	17.5	220-240/50	1.1	1.5	5.8	48.5 Or 50	10.9
HPC-200	470	18.5	220-240/50	1.5	2.0	7.0	48.5 Or 50	11.5



"HPC" SERIES PUMP

"Hpc" series swimming pool pump is designed for medium head installation in medium or domestic pool 1.5 inch suction and discharge port with transparent lid. It operates at a low decibel and easy maintenance.

Highlight Features:

- *Asynchronous, two poles
- *Class insulation: 130
- *IPX5 waterproof standard
- *Built-in thermal protection
- *Overload protection
- *Available for 50Hz or 60Hz with 220v/380v/110v
- *Special design union compatible for both Imperial and Metric measurement standard

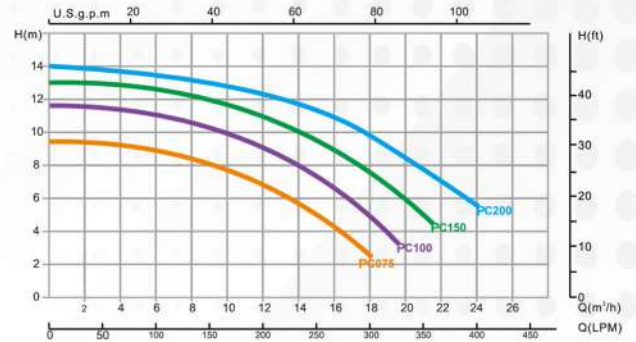

OVERALL DIMENSION

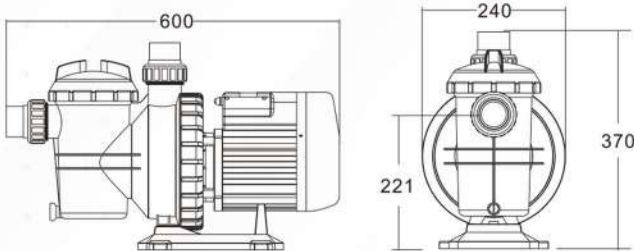

TECHNICAL CHARACTERISTICS

Model	Input Power	Horse Power	Port Size	Weight (Kg)	Packaging Size (mm)
HPC075	0.55KW	0.75HP	1.5 inch / 50mm	12.0	12.10
HPC100	0.75KW	1.0 HP	1.5 inch / 50mm	13.40	13.40
HPC150	1.10KW	1.5 HP	1.5 inch / 50mm	14.90	14.90
HPC200	1.50KW	2.0 HP	1.5 inch / 50mm	14.40	15.40

"HPB" SERIES PUMP

"HPB" series heavy duty pump delivers high flow and energy efficiency ultra performance. It is suitable for commercial swimming pool. 2 inch suction and discharge port with transparent lid. Ring lock seal design to eliminate suction leaks and to maximize suction efficiency.

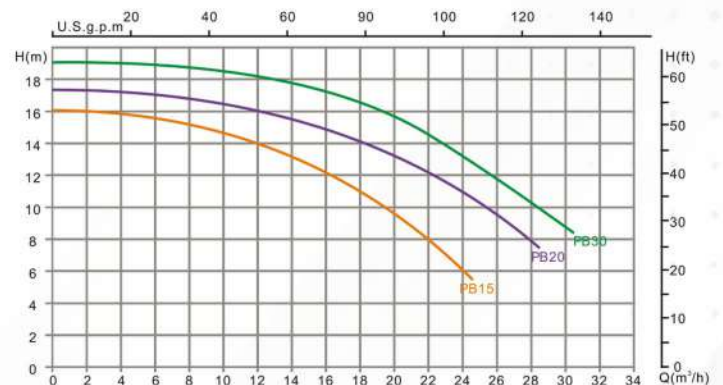

OVERALL DIMENSION

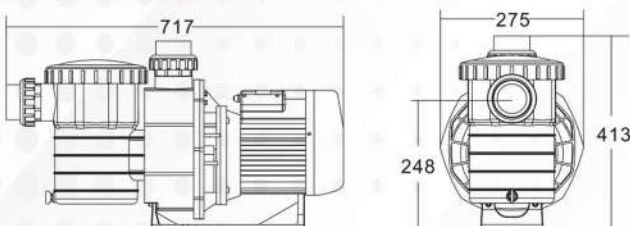

TECHNICAL CHARACTERISTICS

Model	Input Power	Horse Power	Port Size	Weight (Kg)
HPB15	1.10KW	1.5HP	2.0 inch / 63mm	17.00
HPB20	1.50KW	2.0HP	2.0 inch / 63mm	23.00
HPB30	2.20KW	3.0HP	2.0 inch / 63mm	24.00



"HPR" SERIES PUMP

"HPR" series heavy duty pump delivers high flow and energy efficiency ultra performance. It is suitable for commercial spa pool. 2 inch suction and discharge port with transparent lid. Ring lock seal design to eliminate suction leaks and to maximize suction efficiency.

Highlight Features:

- *Asynchronous, two poles
- *Class insulation: 130
- *IPX5 waterproof standard
- *Built-in thermal protection
- *Overload protection
- *Available for 50Hz or 60Hz with 220v/380v/110v
- *Special design union compatible for both Imperial and Metric measurement standard

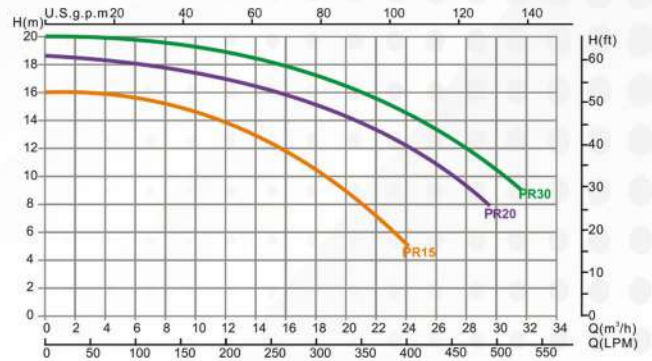

OVERALL DIMENSION

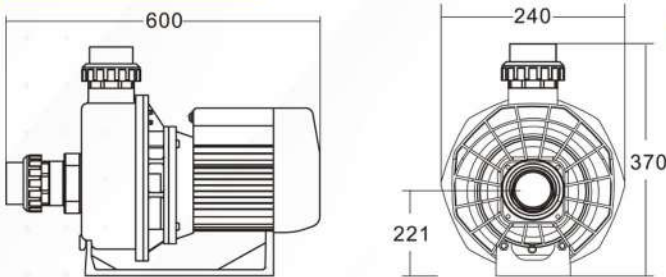

TECHNICAL CHARACTERISTICS

Model	Input Power	Horse Power	Port Size	Weight (Kg)
HPR15	1.10KW	1.5 HP	2.0 inch / 63mm	16.30
HPR20	1.50KW	2.0 HP	2.0 inch / 63mm	19.70
HPR30	2.20KW	3.0 HP	2.0 inch / 63mm	22.10

"HHS" SERIES PUMP

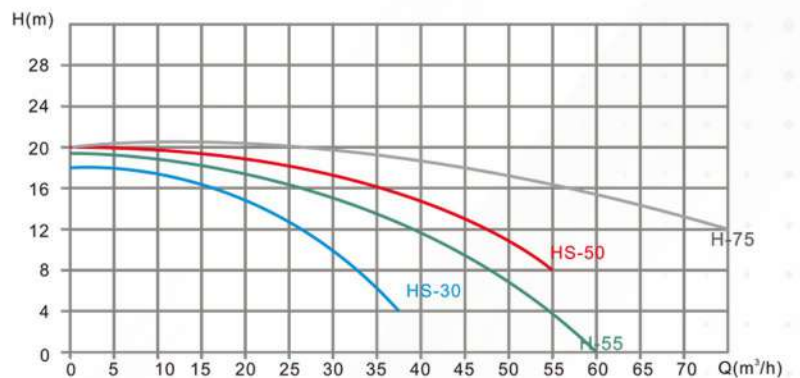

TECHNICAL CHARACTERISTICS

Model	Qmax (m³/h)	Hmax (m)	V/Hz	Weight		Inlet φ D (Inch)	Outlet φ E (Inch)
				Kw	Hp		
HHS-30	38	18	380/50	2.2	3	2.5"/75mm	2.5"/75mm
HHS-50	55	20	380/50	3.8	5	2.5"/75mm	2.5"/75mm
HH-55	60	19	380/50	4.0	5.5	3.0"/90mm	3.0"/90mm
HH-75	80	20	380/50	5.5	7.5	3.0"/90mm	3.0"/90mm

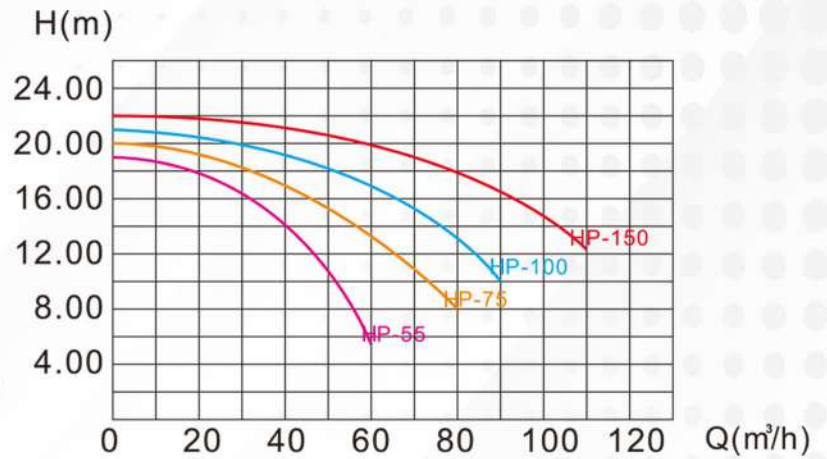

TECHNICAL CHARACTERISTICS

Model	Qmax (m³/h)	Hmax (m)	V/Hz	Weight		Inlet ϕ D (Inch)	Outlet ϕ E (Inch)
				Kw	Hp		
HP-55	60	19	380/50	4	5.5	3.0"/90mm	3.0"/90mm
HP-75	80	20	380/50	5.5	7.5	3.0"/90mm	3.0"/90mm
HP-100	95	21	380/50	7.5	10	3.0"/90mm	3.0"/90mm
HP-150	110	22	380/50	11	15	3.0"/90mm	3.0"/90mm

"HFD" SERIES PUMP

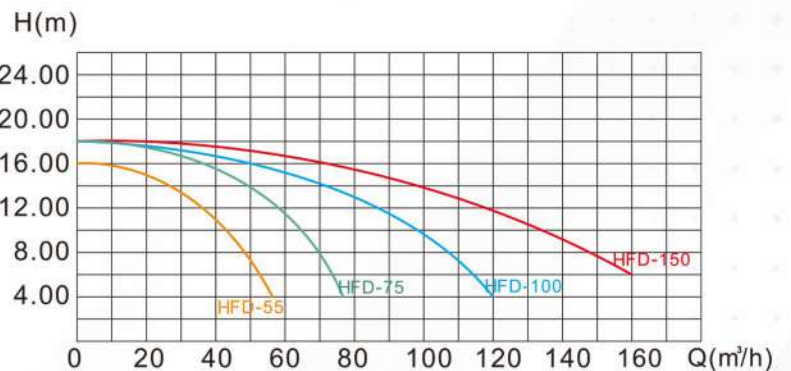

TECHNICAL CHARACTERISTICS

Model	Qmax (m³/h)	Hmax (m)	V/Hz	Inlet Flange (mm)	Outlet Flange (mm)	Inlet ϕ D (Inch)	Outlet ϕ E (Inch)
HFD-75	75	18	380/50	4-M12 ϕ 90	4- ϕ 18 ϕ 75	ϕ 86	ϕ 63
HFD-100	120	18	380/50	8- ϕ 18 ϕ 110	4- ϕ 18 ϕ 90	ϕ 100	ϕ 80
HFD-150	160	18	380/50	8- ϕ 18 ϕ 110	4- ϕ 18 ϕ 90	ϕ 100	ϕ 80





HWE SERIES PUMP

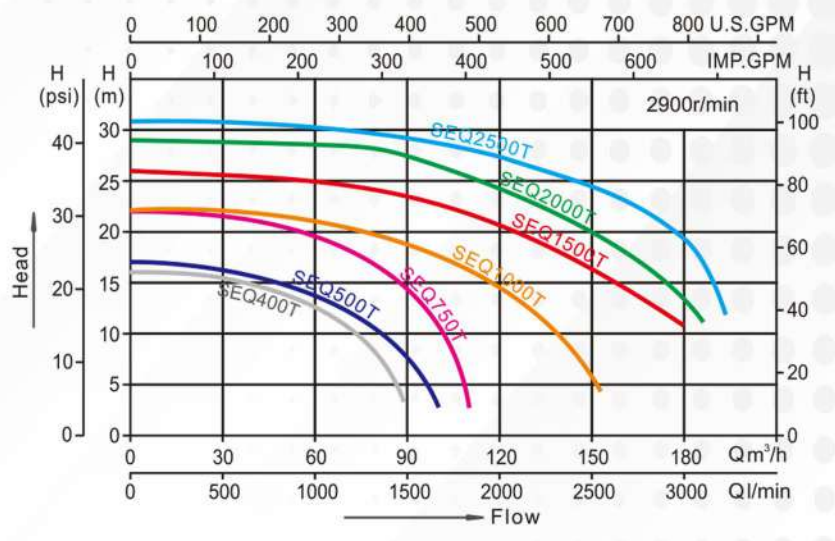

TECHNICAL CHARACTERISTICS

Model	Qmax (m³/h)	Hmax (m)	V/Hz	Power		(Amps)	Inlet/Outlet
				KW	HP		
HWE-400	1480	16	380/50	3.0	4	5.9	(DN150(6"))
HWE-500	1680	17	380/50	4.0	5	6.8	(DN150(6"))
HWE-750	1830	22	380/50	5.5	7.5	10.3	(DN150(6"))
HWE-1000	2560	22	380/50	7.5	10	12.7	(DN150(6"))
HWE-1500	3000	26	380/50	11	15	20.1	(DN150(6"))
HWE-2000	3100	29	380/50	15	20	26.7	(DN150(6"))
HWE-2500	3300	31	380/50	18.5	25	30.3	(DN150(6"))

"HWQ" SERIES PUMP

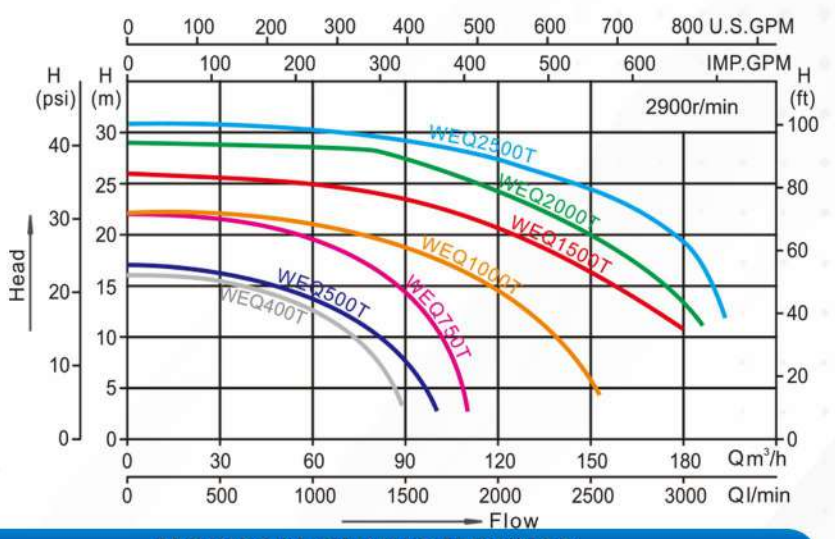

TECHNICAL CHARACTERISTICS

Model	Qmax (m³/h)	Hmax (m)	V/Hz	Power		(Amps)	Inlet/Outlet
				KW	HP		
HWQ-400	1480	16	380/50	3.0	4	5.9	(DN150(6"))
HWQ-500	1680	17	380/50	4.0	5	6.8	(DN150(6"))
HWQ-750	1830	22	380/50	5.5	7.5	10.3	(DN150(6"))
HWQ-1000	2560	22	380/50	7.5	10	12.7	(DN150(6"))
HWQ-1500	3000	26	380/50	11	15	20.1	(DN150(6"))
HWQ-2000	3100	29	380/50	15	20	26.7	(DN150(6"))
HWQ-2500	3300	31	380/50	18.5	25	30.3	(DN150(6"))



SWIM JET 2000

- Jet Swim house made of stainless steel, front and handle made of polished acid-proof stainless steel AISI 304. For mounting in concrete, wood or building block walls.
- Pump power: 3KW
- Control box including contactor and overload protection
- Air mixture control
- Air mixture hose
- Hose connectors
- Hose clamps
- Hose for suction and pressure
- Valves



TECHNICAL CHARACTERISTICS

Model	Power (KW)	Voltage (V)	Pump Connection (mm)	Water Capacity (L/Min)	Jet Material
HPK2000	2.18	220	φ63	35	Stainless Steel

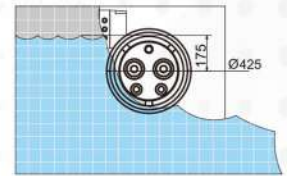
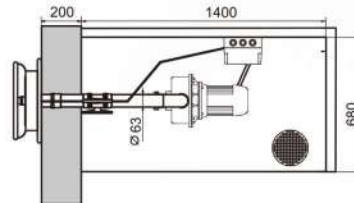
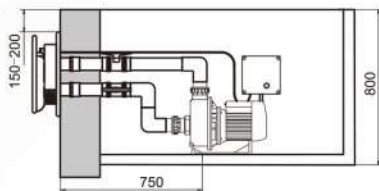

SWIM JET 3000

- Jet Swim house made of stainless steel, front and handle made of polished acid-proof stainless steel AISI 304. For mounting in concrete, wood or building block walls.
- Pump power: 3KW
- Control box including contactor and overload protection
- Air mixture control
- Air mixture hose
- Hose connectors
- Hose clamps
- Hose for suction and pressure
- Valves



TECHNICAL CHARACTERISTICS

Model	Power (KW)	Voltage (V)	Pump Connection (mm)	Water Capacity (L/Min)	Jet Material
HPK3000	3	220/380	φ75	70	Bronze, Stainless Steel



WP-4HP/220v/380v

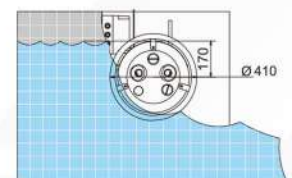
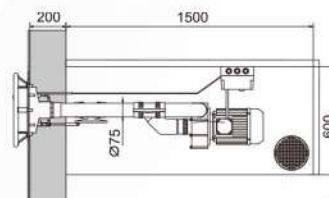
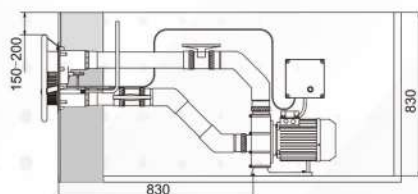



PROPULSION SYSTEM

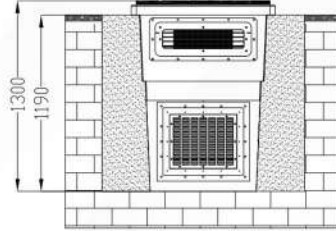
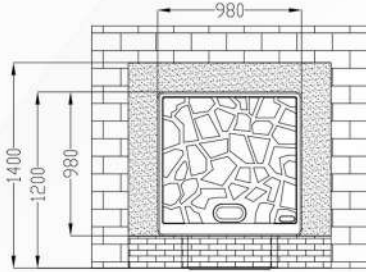

HPK8100

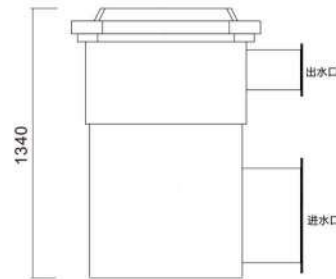
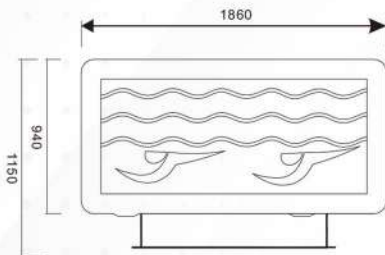
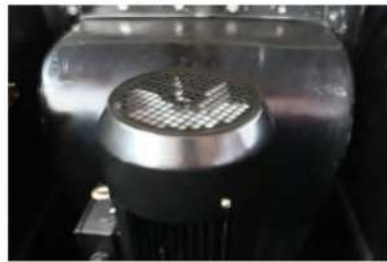

HPK8000



The propulsion system is made of high-density fiberglass and acrylic materials, high load and high temperature operation, more reliable. As a new generation swimming machine developed, it's a device for infinity swimming, turning the small pool into an endless pool. Through a special hydraulic pushing device a directional water flow is formed and pushed to the swimmer to achieve the purpose of exercise.

TECHNICAL CHARACTERISTICS

Model	Power (KW)	Voltage (V)	Packaging Size (mm)
HPK8100	2.8	380	1200x980x1300
HPK8000	2x2.8	380	1860x1150x1340



UNDER WATER
LIGH SERIES

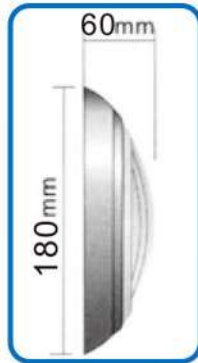

HPK6001S Wall Mounted Type Pool Light

Material: 304 Stainless Steel	Waterproof Standard: IP68
Cable: 3x1.5mm ² x1.5m	Available: LED 6x1W/12V (White Color / Automatic Color Change)



HPK6003 Wall Mounted Type Pool Light

Material: 304 Stainless Steel	Available:
Cable: 3x1.5mm ² x1.5m	1. 100W/12V Halogen light bulb
Waterproof Standard: IP68	2. LED 9x1W/12V
(White Color / Auto Color Change)	3. LED 12x1W/12V



HPK6001 Wall Mounted Type Pool Light

Material: 304 Stainless Steel	Available:
Cable: 2x1.5mm ² x1.5m	1. 100W/12V Halogen light bulb
Waterproof Standard: IP68 (White Color / Auto Color Change)	2. 144 LED Bulbs 12W/12V
	3. 252 LED Bulbs 25W/12V
	4. LED 18x1W/12V
	5. LED 24x1W/12V

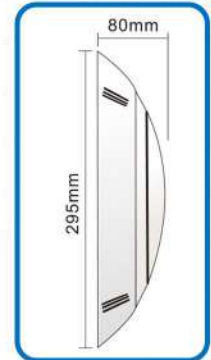

HPK6005 Wall Mounted Type Pool Light

Material: ABS + UV	Available:
Cable: 2x1.5mm ² x1.5m	1. 100W/12V Halogen light bulb
Waterproof Standard: IP68 (White Color / Auto Color Change)	2. 144 LED Bulbs 12W/12V
	3. 252 LED Bulbs 25W/12V
	4. LED 12x1W/12V
	5. LED 18x1W/12V



HPK6004S Wall Mounted Type Pool Light

Material: ABS + UV	Available:
Cable: 3x1.5mm ² x1.5m	1. 100W/12V Halogen light bulb
Waterproof Standard: IP68 (White Color / Auto Color Change)	2. 144 LED Bulbs 12W/12V
	3. LED 9x1W/12V
	4. LED 12x1W/12V

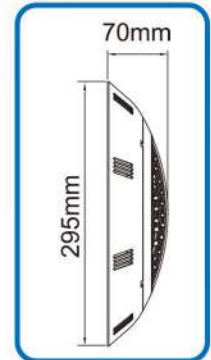

HPK6004 Wall Mounted Type Pool Light

Material: ABS + UV	Available:
Cable: 2x1.5mm ² x1.5m	1. 100W/12V Halogen light bulb
Waterproof Standard: IP68 (White Color / Auto Color Change)	2. 144 LED Bulbs 12W/12V
	3. 252 LED Bulbs 25W/12V
	4. LED 9x1W/12V
	5. LED 12x1W/12V
	6. LED 18x1W/12V
	7. LED 24x1W/12V



HPK6006 Wall Mounted Type Pool Light

Material: ABS + UV

Cable: 2x1.5mm²x1.5m

Waterproof Standard: IP68

Available:

1. 100W/12V Halogen light bulb
2. 144 LED Bulbs 12W/12V
3. 252 LED Bulbs 25W/12V
4. LED 9x1W/12V
5. LED 12x1W/12V
6. LED 18x1W/12V

(White Color / Auto Color Change)



HPK6007 Wall Mounted Type Pool Light

Material: ABS + UV

Cable: 2x1.5mm²x1.5m

Waterproof Standard: IP68

Available:

1. 100W/12V Halogen light bulb
2. 144 LED Bulbs 12W/12V
3. 252 LED Bulbs 25W/12V
4. LED 9x1W/12V
5. LED 12x1W/12V
6. LED 18x1W/12V

(White Color / Auto Color Change)

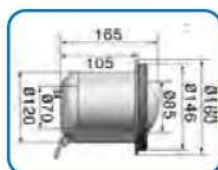

HPK6010 Buried Type Pool Light

Material: 304 Stainless Steel

Cable: 3x2.5mm²x1.5m

Waterproof Standard: IP68

Available:

1. 100W/12V Halogen light bulb
2. 36 LED Bulbs 3W/12V
3. 90 LED Bulbs 6W/12V

(White Color / Auto Color Change)

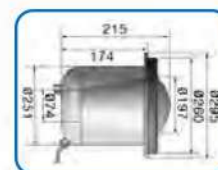

HPK6011 Buried Type Pool Light

Material: 304 Stainless Steel

Cable: 3x4mm²x1.5m

Waterproof Standard: IP68

Available:

1. 300W/12V Halogen light bulb
2. 252 LED Bulbs 18W/12V

(White Color / Auto Color Change)



HPK6017 Buried Type Pool Light

Material: ABS + UV

Cable: 2x4mm²x1.5m

Waterproof Standard: IP68

Available:

1. 300W/12V Halogen light bulb
2. 252 LED Bulbs 18W/12V
3. 441 LED Bulbs 35W/12V
4. 546 LED Bulbs 40W/12V
5. LED 12x1W/12V
6. LED 18x1W/12V
7. LED 24x1W/12V
8. LED 18x3W 35W/12V

(White Color / Auto Color Change)

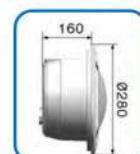

HPK6017V Buried Type Pool Light (For Liner Pool)

Material: ABS + UV

Cable: 2x4mm²x1.5m

Waterproof Standard: IP68

Available:

1. 300W/12V Halogen light bulb
2. 252 LED Bulbs 18W/12V
3. 441 LED Bulbs 35W/12V
4. LED 12x1W/12V
5. LED 18x1W/12V
6. LED 24x1W/12V
7. LED 18x3W 35W/12V

(White Color / Auto Color Change)



HPK6016 Buried Type Pool Light

Material: ABS + UV

Cable: 2x4mm²x1.5m

Waterproof Standard: IP68

Available:

1. 300W/12V Halogen light bulb
2. 252 LED Bulbs 18W/12V
3. 441 LED Bulbs 35W/12V
4. 546 LED Bulbs 40W/12V
5. LED 12x1W/12V
6. LED 18x1W/12V
7. LED 24x1W/12V
8. LED 18x3W 35W/12V

(White Color / Auto Color Change)



HPK6016A Buried Type Pool Light

Material: ABS + UV

Cable: 2x4mm²x1.5m

Waterproof Standard: IP68

Available:

1. 300W/12V Halogen light bulb
2. 252 LED Bulbs 18W/12V
3. 441 LED Bulbs 35W/12V
4. 546 LED Bulbs 40W/12V
5. LED 12x1W/12V
6. LED 18x1W/12V
7. LED 24x1W/12V
8. LED 18x3W 35W/12V

(White Color / Auto Color Change)



HPK6625

Material: AISI-304 Stainless steel

Watt/Voltage: 7x1W/12V

Waterproof: IP68

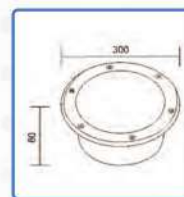

HPK6626

Material: AISI-304 Stainless steel

Watt/Voltage: 9x1W/12V

Waterproof: IP68



HPK6627

Material: AISI-304 Stainless steel

Watt/Voltage: 24W/18W/12V

Waterproof: IP68

Watt/Voltage: 300W/12V (PAR56)

Cable: 3x2.5mm²x2.0m

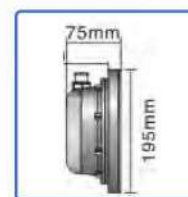

HPK6628

Material: AISI-304 Stainless steel

Watt/Voltage: 12W/9W/6W/12V

Waterproof: IP68

Watt/Voltage: 100W/12V

Cable: 3x2.5mm²x2.0m



HPK6629

Material: AISI-304 Stainless steel

Watt/Voltage: 3x1W/12V

Waterproof: IP68

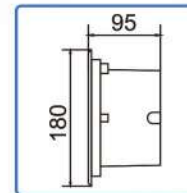

HPK6630

Material: AISI-304 Stainless steel

Watt/Voltage: 9x1W/12V

Waterproof: IP68

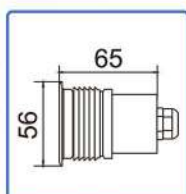

HPK6631

Material: AISI-304 Stainless steel

Watt/Voltage: 1W/12V

Waterproof: IP68

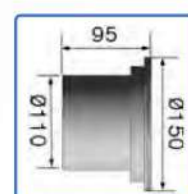

HPK6632

Material: AISI-304 Stainless steel

Watt/Voltage: 12W/9W/6W/12V

Waterproof: IP68



RGB SERIES UNDERWATER LIGHT

RGB REMOTE CONTROL

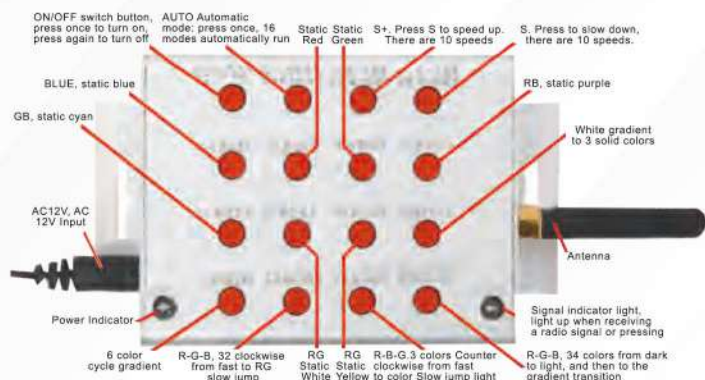

REMOTE CONTROL ARM

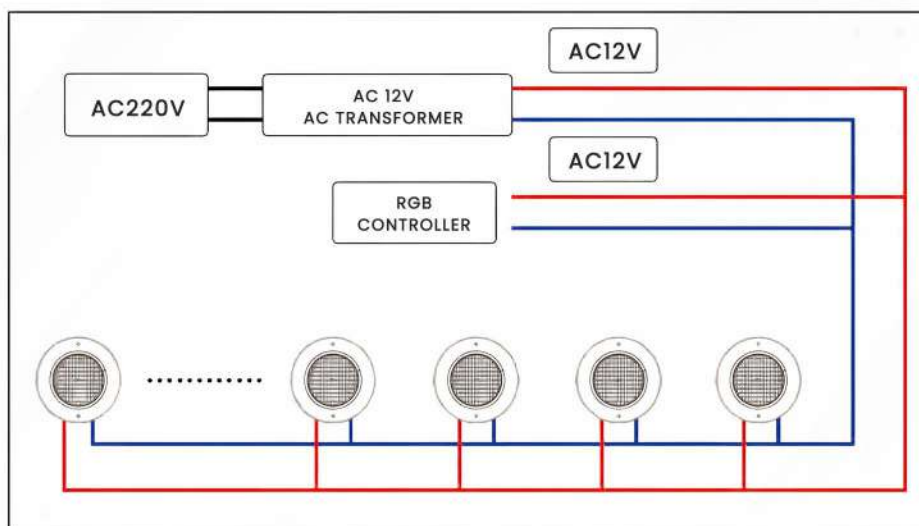

RGB MODE FUNCTION DESCRIPTION

- MODE 1: STATIC BLUE
- MODE 2: STATIC RED
- MODE 3: STATIC GREEN
- MODE 4: STATIC PURPLE
- MODE 5: STATIC CYAN
- MODE 6: STATIC YELLOW
- MODE 7: STATIC WHITE
- MODE 8: (RGB MATERIAL) RG IS ALWAYS BRIGHT, AND FADES TO 1.9S (R↓ G) G IS ALWAYS BRIGHT, AND R FADES TO 1.9S → (GL) G FADES TO 1.9S (RGB) RB IS ALWAYS BRIGHT, AND G FADES TO 1.9S+ (RB↓) R IS ALWAYS ON, GRADUALLY GETTING DARKER 1.9S + (RI) R IS GETTING DARKER 1.9S (RGB) GB IS ALWAYS BRIGHTER, R IS GETTING DARKER 1.9S → (G↓ B) DAY IS ALWAYS BRIGHTER, G IS GETTING DARKER 1.9S → (B↓) DAYTIME IS GETTING DARKER 1.9S CYCLE.
- MODE 9: (G↓ B↑) RED FADES TO DARK WHILE GREEN FADES TO BRIGHT 1.9S+ (GBT) GREEN FADES TO DARK WHILE BLUE FADES TO BRIGHT 1.9S (RT B↓) BLUE FADES TO DARK WHILE RED FADES TO BRIGHT 1.9S LOOP .
- MODE 10: R (60MS) → G(60MS) → B(60MS) → CYCLE 10 TIMES R(120MS) → G(120MS) → B(120MS) → CYCLE 5 TIMES → R(180MS) → G(180MS) → B(180MS) CYCLE 5 TIMES → R(240MS) → G(240MS) → DAY(240MS) + CYCLE 5 TIMES → CYCLE FROM THE BEGINNING (CLOCKWISE ROTATION)
- MODE 11: R(100MS) → DAY(100MS) → G(100MS) → LOOP 5 TIMES → R(160MS) → B(160MS) → G(160MS) + CYCLE 5 TIMES (220MS) → B(220MS) → G(220MS) → CYCLE 5 TIMES (280MS) → B(280MS) → G(280MS) → CYCLE 5 TIMES → CYCLE FROM THE BEGINNING (COUNTER CLOCKWISE ROTATION)
- MODE 12: (RT) RED FADES TO BRIGHTER 1.9S (R↑) RED FADES TO DARKER 1.9S (G↑) GREEN FADES TO BRIGHTER 1.9S (G↑) GREEN FADES TO DARKER 1.9S (B↑) BLUE FADES BRIGHT 1.9S → (B↓) BLUE COLOR FADES 1.95 CYCLES.

THE TIME IS BASED ON THE FASTEST SPEED! GEAR G↓ B↑ IS THE GUIDELINE. THE 2ND GEAR IS SLOWER BY 1 LETTER 2T, AND THE 3RD GEAR IS -3T105-10



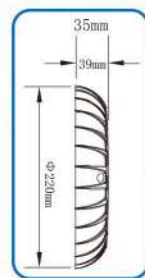
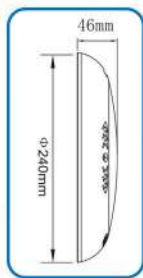

HPK8001 Wall Mounted Type Pool Light

Material: PC	Available:
Cable: 2x1.0mm ² x1.5m	<ol style="list-style-type: none"> 1. LED Bulbs 18W/12V/24V 2. LED Bulbs 25W/12V/24V 3. LED Bulbs 35W/12V/24V 4. LED Bulbs 40W/12V/24V
Waterproof Standard: IP68	(White Color / Auto Color Change)

HPK8002 Wall Mounted Type Pool Light

Material: PC	Available:
Cable: 2x1.0mm ² x1.5m	<ol style="list-style-type: none"> 1. LED Bulbs 12W/12V/24V 2. LED Bulbs 18W/12V/24V 3. LED Bulbs 25W/12V/24V 4. LED Bulbs 9x1W/12V/24V 5. LED Bulbs 12x1W/12V/24V
Waterproof Standard: IP68	(White Color / Auto Color Change)

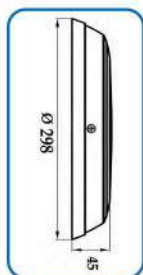

HPK8003 Wall Mounted Type Pool Light

Material: 304 Stainless Steel	Available:
Cable: 3x1.0mm ² x1.5m	<ol style="list-style-type: none"> 1. LED Bulbs 18W/12V/24V 2. LED Bulbs 25W/12V/24V 3. LED Bulbs 35W/12V/24V 4. LED Bulbs 40W/12V/24V 5. LED Bulbs 12x1W/12V/24V 6. LED Bulbs 18x1W/12V/24V
Waterproof Standard: IP68	(White Color / Auto Color Change)

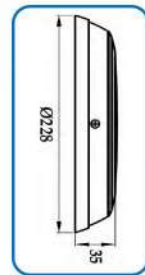

HPK8004S Wall Mounted Type Pool Light

Material: PC	Available:
Cable: 3x1.0mm ² x1.5m	<ol style="list-style-type: none"> 1. LED Bulbs 12W/12V/24V 2. LED Bulbs 18W/12V/24V 3. LED Bulbs 25W/12V/24V 4. LED Bulbs 12x1W/12V/24V 5. LED Bulbs 18x1W/12V/24V
Waterproof Standard: IP68	(White Color / Auto Color Change)

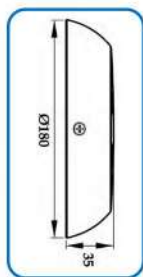

HPK8005S Wall Mounted Type Pool Light

Material: PC	Available:
Cable: 2x1.0mm ² x1.5m	<ol style="list-style-type: none"> 1. LED Bulbs 12W/12V/24V 2. LED Bulbs 18W/12V/24V 3. LED Bulbs 25W/12V/24V 4. LED Bulbs 9x1W/12V/24V 5. LED Bulbs 12x1W/12V/24V
Waterproof Standard: IP68	(White Color / Auto Color Change)

TRANSFORMERS



HVTP-041
Transformers
(220V→12V) 50Hz/60Hz
50W / 100W / 150W / 200W
300W / 400W / 500W / 600W



HVTP-042
Transformers
(220V→12V) 50Hz/60Hz
60W / 105W / 200W /
300W / 400W



HSP-034
Junction Box



HVTP-043
Transformers
(220V→12V) 50Hz/60Hz
500W / 600W / 800W / 1000W



WATER DESCENT

"HORBO" water descent provide several sizes and configurations to be available for different installation requirements. With a suitable water pump and filtration system, you can enjoy vibrant water falling effect, which will bring elegance and visual interest to the private gardens, swimming pools, parks or gardens. The soothing sound of the water flowing will add pleasure to people.

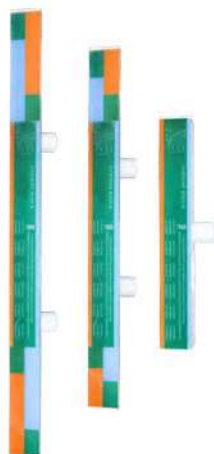

- + High stability, advanced artificial waterfall over in China
- * Built-in waterproof LED lights to beautify the water color
- * The LED lights are powered by 12V DC, RGB light source are safe and reliable
- + The LED lights can be operated through remote control, different light mode changes
- + The outlets of the waterfall are available in different sizes to meet different installation requirements
- + Multiple water descent systems can be connected to one controller to meet the effect synchronization of light mode

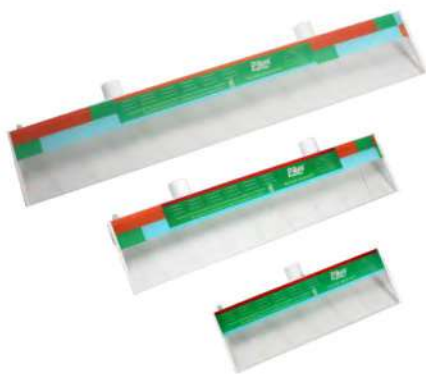

Approximate projection of sheet of water per 300mm of waterall length.

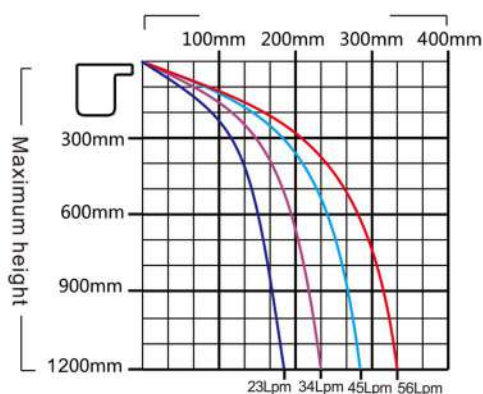

"HORBO" water descent are suitable for installation on finished walls and new construction walls, as well length and thickness of the wall product design unique novel, beautiful. Efficient to hide the outlet, Showing a beautiful linear effect of the water.

TECHNICAL INFORMATION

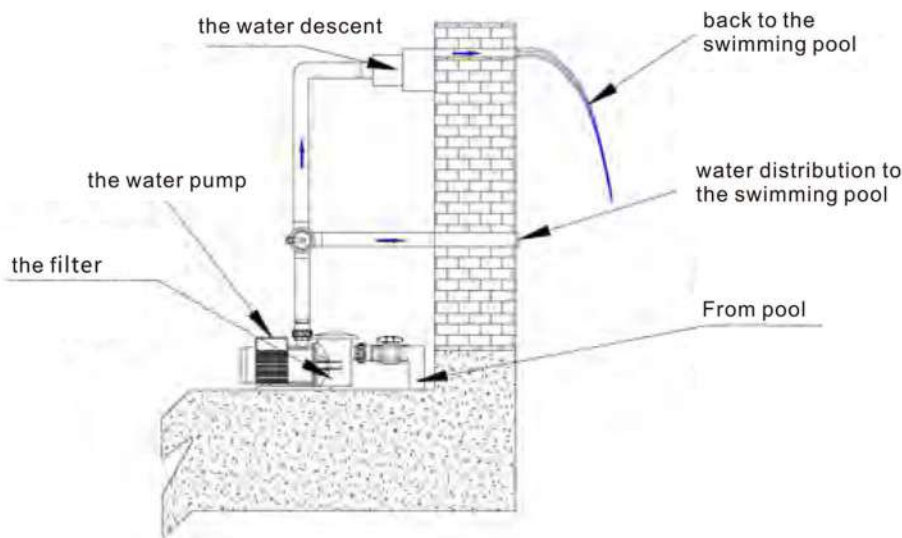

MULTIPLE WATER DESCENT WITH VALVE MOUNTING

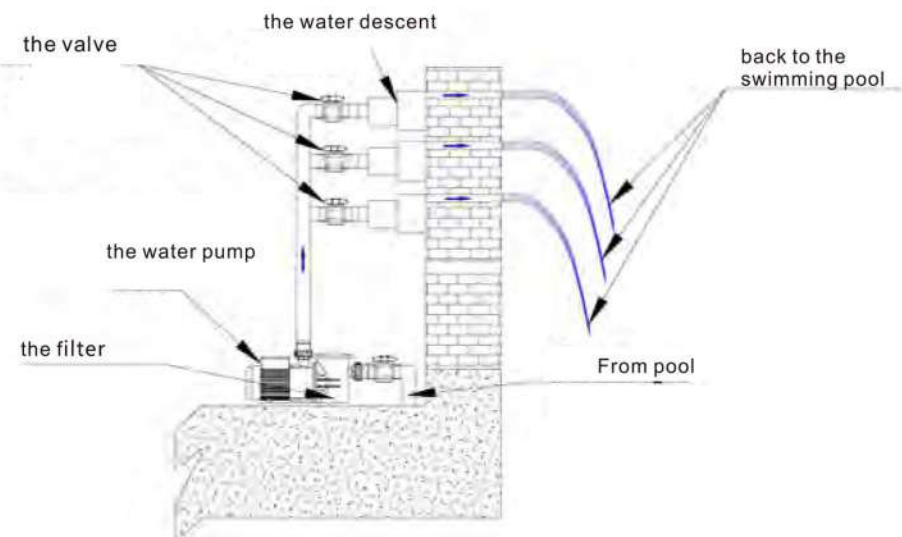

With LED Light

Model	Connection Size	A mm	B mm	C mm	D mm	Power	Voltage
HWD300-25-LED	1.5 Inch 50 mm	306	138	76	25	4W	DC12V
HWD300-150-LED	1.5 Inch 50 mm	306	263	76	150	4W	DC12V
HWD300-230-LED	1.5 Inch 50 mm	306	343	76	230	4W	DC12V
HWD600-25-LED	1.5 Inch 50 mm	606	138	76	25	8W	DC12V
HWD600-150-LED	1.5 Inch 50 mm	606	263	76	150	8W	DC12V
HWD600-230-LED	1.5 Inch 50 mm	606	343	76	230	8W	DC12V
HWD900-25-LED	1.5 Inch 50 mm	906	138	76	25	12W	DC12V
HWD900-150-LED	1.5 Inch 50 mm	906	263	76	150	12W	DC12V
HWD900-230-LED	1.5 Inch 50 mm	906	343	76	230	12W	DC12V
HWD1200-25-LED	1.5 Inch 50 mm	1206	138	76	25	17W	DC12V
HWD1200-150-LED	1.5 Inch 50 mm	1206	263	76	150	17W	DC12V
HWD1200-230-LED	1.5 Inch 50 mm	1206	343	76	230	17W	DC12V

Without LED Light

Model	Connection Size	A mm	B mm	C mm	D mm	Power	Voltage
HWD300-25	1.5 Inch 50 mm	306	138	76	25	-	-
HWD300-150	1.5 Inch 50 mm	306	263	76	150	-	-
HWD300-230	1.5 Inch 50 mm	306	343	76	230	-	-
HWD600-25	1.5 Inch 50 mm	606	138	76	25	-	-
HWD600-150	1.5 Inch 50 mm	606	263	76	150	-	-
HWD600-230	1.5 Inch 50 mm	606	343	76	230	-	-
HWD900-25	1.5 Inch 50 mm	906	138	76	25	-	-
HWD900-150	1.5 Inch 50 mm	906	263	76	150	-	-
HWD900-230	1.5 Inch 50 mm	906	343	76	230	-	-
HWD1200-25	1.5 Inch 50 mm	1206	138	76	25	-	-
HWD1200-150	1.5 Inch 50 mm	1206	263	76	150	-	-
HWD1200-230	1.5 Inch 50 mm	1206	343	76	230	-	-

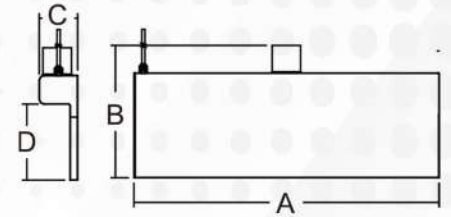

HK-01



HK-25



HK-25



HK-02

Product Number	Model	Product Description	Operating Temperature	Input	Output	Transmitting Distance
08080016	HK24 / HK-02	LED CONTROL BOX	-20+40°C	AC 100V-240V 50/60HZ	DC 12V/24W	3M
08080017	HK25/ HK-01	LED CONTROL BOX	-20+40°C	AC 100V-240V 50/60HZ	DC 12V/60W	20M

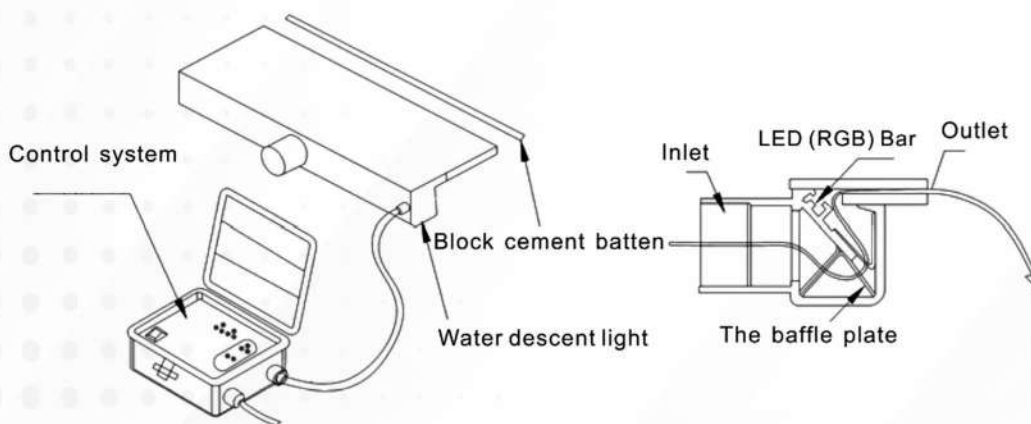

Do not move the retaining bar before installation is complete, and avoid prolonged exposure to the sun!

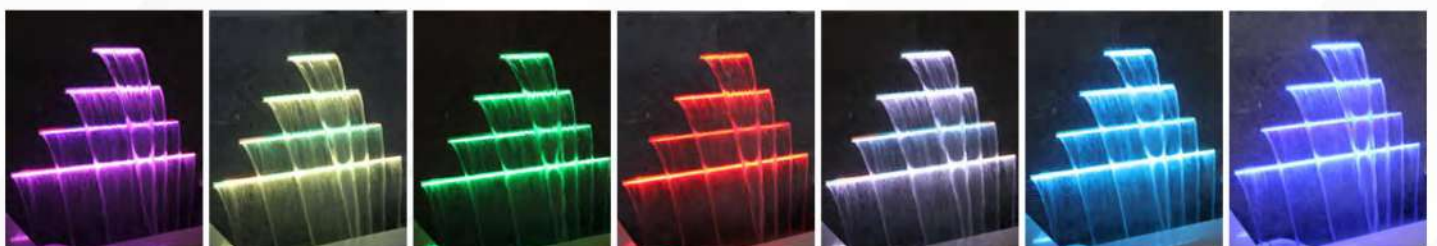

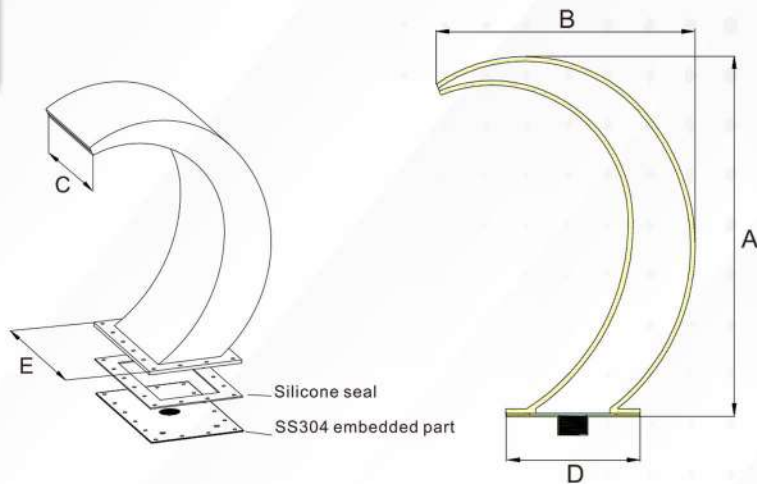

Technical Characteristics

Model	Take Over Size		A mm	B mm	C mm	D mm	E mm	Power	Voltage
HWF-300	1.5 Inch	50 mm	603	423.5	320	236	416	-	-
HWF-301	2 Inch	63 mm	750	540.6	395	280	500	-	-
HWF-300LED	1.5 Inch	50 mm	603	423.5	320	236	416	12.0W	DC12V
HWF-301LED	2 Inch	63 mm	750	540.6	395	280	500	13.0W	DC12V

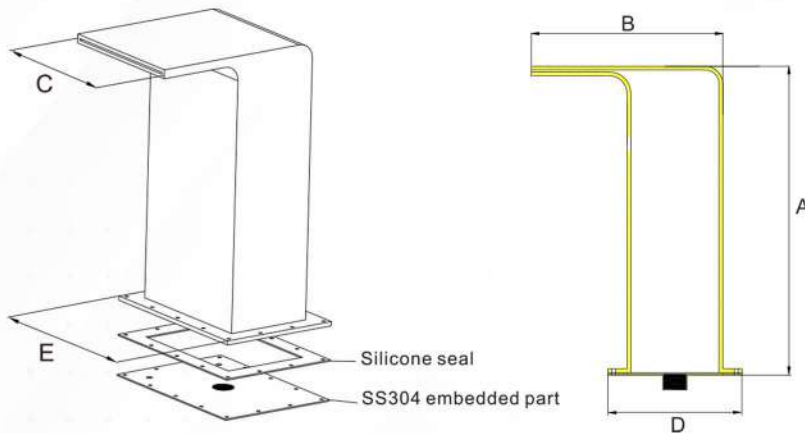

Technical Characteristics

Model	Take Over Size		A mm	B mm	C mm	D mm	E mm	Power	Voltage
HWF-302	1.5 Inch	50 mm	603	450	300	280	400	-	-
HWF-303	2 Inch	63 mm	800	500	400	350	500	-	-
HWF-302LED	1.5 Inch	50 mm	603	450	300	280	400	13.0W	DC12V
HWF-303LED	2 Inch	63 mm	800	500	400	350	500	14.0W	DC12V



HK-01



HK25

MODEL : HK25

Operating Temperature	20~+40°C
Input	AC 100V-220V 50/60Hz
Output	DC 12V/60W
Transmitting Distance	20m

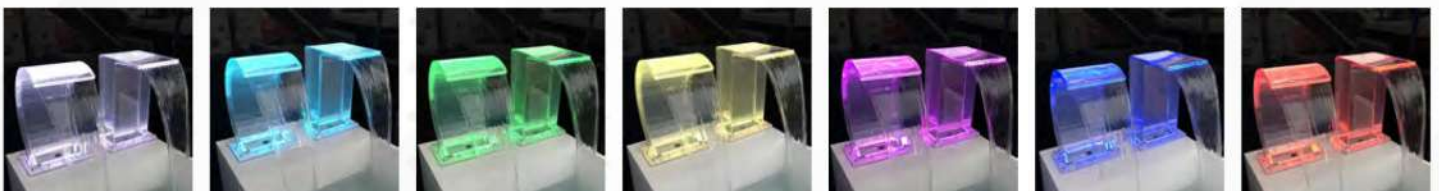



HORBO SPA SERIES





SPA SERIES

Description	Model No.	Material	Lenth (mm)	Width (mm)
Spa Bed	HVTSPA-14	Acrylic	1996	830

Thousands of tiny oxygenated water bubbles surge out from the back of the recliner and wrap around the human body, Forming a water film on the surface of the skin, delicately . caressing the human body's skin and acupoints, on the one hand. It can restore the skin's tension and elasticity and replenish moisture; on the other hand, it can relieve nervousness. Mood, eliminate insomnia and other symptoms.

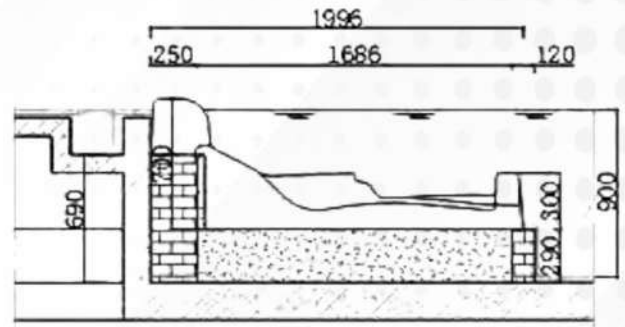

Description	Model No.	Material	Lenth (mm)	Width (mm)
Massage Seat	HVTSPA-15	Acrylic	950	700



Soak in hot water to quickly open the pores of the human body, and multiple sets of massage nozzles massage the shoulders, back, buttocks, and soles of the human body.

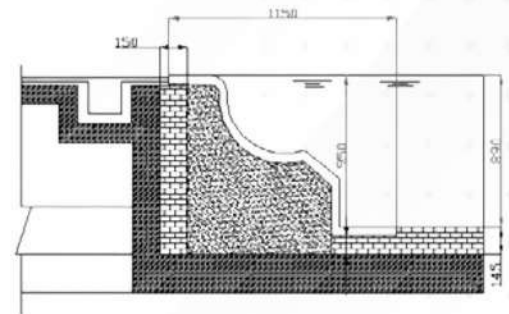

Description	Model No.	Material	Lenth (mm)	Width (mm)
Massage Seat	HVTSPA-09	Acrylic	890	600



Using hot water to soak, the pores of the human body are quickly opened, and multiple sets of massage nozzles are used to massage the human body's legs and back.

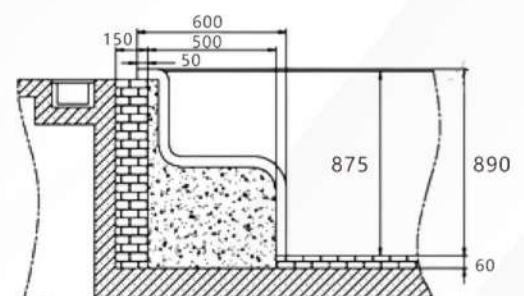



HVTSPA-05
VICHY SHOWER



HVTSPA-06B
WATER PRESSURE MASSAGE BED
(1860*680MM)



HVTSPA-06A
WATER PRESSURE MASSAGE BED
(1860*680MM)



HVTSPA-17
HYDROTHERAPY BED
(1900*720MM)



HVTSPA-03
SALT BATH HYDROMASSAGE BED
(2150*1060*610MM)



HVTSPA-02
SALT BATH HYDROMASSAGE BED
(2150*1060*610MM)



HVTSPA-01
SALT BATH BED
(2100*1060*570MM)



HVTSPA-05
WATER FOOT MASSAGER
(580*360*480MM)



HVTSPA-11
MASSAGE BED
(1900*600*600MM)





HVTP-33301

Exquisite Purple Crystal Sensor	φ130x65
Single Channel Induction Controller (Disk Assembly)	66x72x115



HVTP-33302

Diamond Purple Crystal Sensor	φ130x70
Single Channel Induction Controller (Disk Assembly)	66x72x115



HVTP-33304

Frosted White Crystal Sensor	φ130x65
Single Channel Induction Controller (Disk Assembly)	66x72x115



HVTP-33305

Diamond White Crystal Sensor	φ130x90
Single Channel Induction Controller (Disk Assembly)	66x72x115



HVTP-338

STAINLESS STEEL & CRYSTAL SENSOR
φ90X40



HVTSPA-02

CHROMIUM PLATED ABS & SIWER ABS SENSOR
φ90X40



HVTP-340

STAINLESS STEEL INCLINED COLUMN
& ABS SENSOR
φ115X90

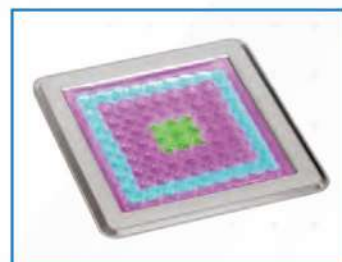

HVTP-33306

UNDER WATER MASSAGE LAMP
113X113X81



HVTP-33311

SMALL DISPLAY SCREEN (WALL HANGING)
270X150X30



HVTP-33309

SMALL DISPLAY SCREEN
(CONCEALED INSTALLATION)
265X130X30



HVTP-33310

DOUBLE SIDED DESKTOP DISPLAY SCREEN
(TWO SIDES & TWO TEMPERATURE)
270X140X100



HVTP-33312

BIG DISPLAY SCREEN (WALL HANGING)
265X270X30





HVT-022
FAN SHAPE
SHOWER



HVT-023
UNIVERSAL
PHOENIX
TAIL SHOWER



HVT-030
DUCK MOUTH
IMPACTOR SHAPE
SHOWER



HVT-020
HEAVY RAIN
SHOWER



HVT-011
UNIVERSAL
STRENGTH
SHOWER



HVT-010
UNIVERSAL
AIR JET
SHOWER



HVT-0004
AERATED NOZZLE



HVT-0007
PHOENIX TAIL NOZZLE



HVT-00023
UNIVERSAL JADE CHOPSTICK
SHOWER NOZZLE



HVT-0011
SPRAYING ROUND NOZZLE



HVT-0006
HEAVY RAIN NOZZLE



HVT-0003
UNIVERSAL WATER
HAMMER NOZZLE



HVT-0014
SLIMMING NOZZLE



HVT-0012/13
DUCK MOUNTH
SHUP NOZZLE



HVT-0009
FIVE HOLES ROUND NOZZLE



HVT-0010
THREE HOLES ROUND NOZZLE



HVT-0018
SINGLE HOLE BUBBLE NOZZLE



HVT-0019
THREE HOLE BUBBLE NOZZLE



HVT-061
BALL SHAPE
RAIN SHOWER



HVT-062
BALL SHAPE
RAIN SHOWER



HVT-063
BALL UNIVERSAL
HAMMER SHOWER



HVT-064
BALL UNIVERSAL
DUCK SHOWER



HVT-065
NEW HEAVY
RAIN SHOWER



HVT-066
NEW DUCK MONTH
SHAPE SHOWER



HVT-068
DOUBLE
HEAD SHOWER

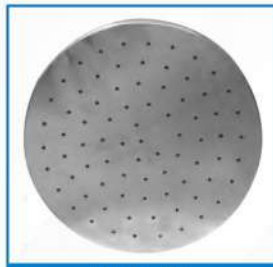

HVT-111
ROUND BUBBLE SHOWER
SIZE: ϕ 300MM

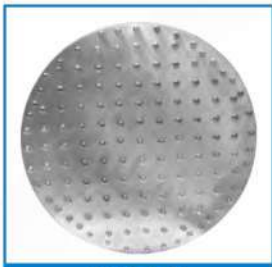

HVT-110
ROUND SPRAYING SHOWER
SIZE: ϕ 300MM



HVT-112
FOUNTAIN NOZZLE
SIZE: ϕ 300MM

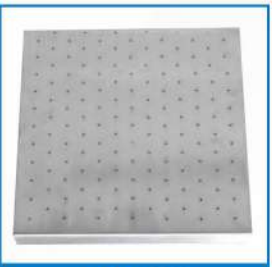

HVT-113
SQUARE BUBBLE SHOWER
SIZE: 350X350MM

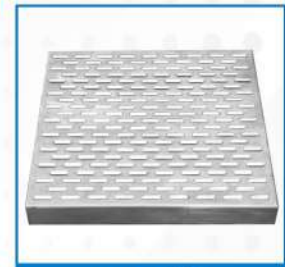

HVT-116
FLOATING BATH SPRAY BOARD
SIZE: 350X350MM



HVT-115
SIZE: 250X180MM



HVT-117
HIPS MASSAGE
SIZE: 400X25MM



HVT-120
WATER FOOT HYDRAULIC MASSAGER
SIZE: 350X350MM

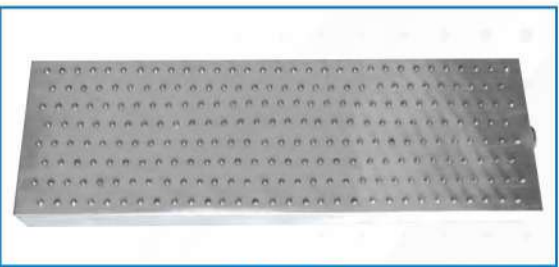

HVT-114
RAIN SHOWER
SIZE: 1000X300X100MM



HVT-118
STAINLESS STEEL SPA MASSAGE CHAIR
SIZE: 600X500MM



HVT-121
ACUPUNCTURE SHOWER



HVT-128
BODY MASSAGE SHOWER



HVT-123
NINE HOLE BUBBLE DEVICE



HVT-122
BATH BRACKET



HVT-067
ACUPUNCTURE SHOWER



HVT-133
BARREL IMPACT



HVT-137
PATTING BATH
SIZE: 1500X350X1700MM



HVT-136
STAINLESS STEEL AIR BUBBLE BED
SIZE: 1700X600MM



HVT-125
VICHY SHOWER
SIZE: 980X220MM



HVT-119
VICHY SHOWER
SIZE: 2600X1600X200MM



HVT-119
VICHY SHOWER
SIZE: 2000X200MM



HVT-131
WATER LINK



HVT-135B
HAIR COLLECTOR
DN50/DN80/DN100/DN150



HVT-135A
HAIR COLLECTOR
DN50/DN80/DN100/DN150



HVT-135C
HAIR COLLECTOR
DN50/DN80/DN100/DN150



HVT-139
FORCED SHOWER





DOLPHIN
HP-04 H=1330MM



PENGUIN
HP-08 H=1330MM



FISH
HP-03 H=1340MM



GOLDEN DRAGON
HP-02 H=1450MM



CLOWN
HP-10



CONCH
HP-09



SEA LION
HP-06 H=1400MM



LITTLE ELEPHANT
HP-07 H=1320MM



HIPPOCAMPI
HP-05 H=1400MM



φ1500X2000MM
φ1250X2000MM
φ1000X2000MM

HVT301
WATER MUSHROON



SIZE :600, 800, 1000, 1200MM

HVT302
STAINLESS STEEL
WATER MUSHROON

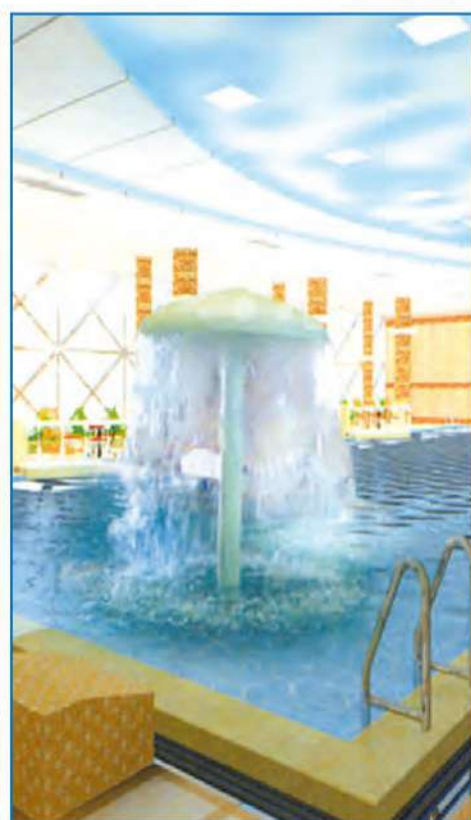



HORBO MACHINE ROOM EQUIPMENT





HVTP-002



HVTP-003

FEATURE

- Centrifugal vanes make high pressure, great outflow and low noise.
- High quality engine ensures safe and steady effect. Non-oil lubrication and pure compressed air. Phosphorize disposition, regular coloring and adhesive strength.
- Wide range of power, long life of this machine.

APPLICATION

- To be used in paper cutters, filter cigarette shapers, pulverizingdries, net printers, photo plate makers, liquid-canning machines, electric welding equipment, film machinery, plate makers, liquicanning machines, electric welding equipment, film machinery, papertransporting, clothes dry-cleaning, rinsing, air cleaning, pneumatic conveying, material conveying, collection and so on.

NOTE

- The products must be put at dry and ventilated places abovewater level.

TECHNICAL CHARACTERISTICS

Model	Voltage	Power	Pressure	Vacuum	Output	Pressure	Weight	Dimensions
HXB-550	220v/380v/50Hz	550w	15kPa	-12kPa	95m ³ /h	< 10kPa	10kg	294x288x315mm
HXB-750	220v/380v/50Hz	750w	18kPa	-14kPa	110m ³ /h	< 10kPa	14kg	294x288x315mm
HXB-1100	220v/380v/50Hz	1100w	22kPa	-18kPa	165m ³ /h	< 16kPa	20kg	313x333x339mm
HXB-1500	220v/380v/50Hz	1500w	25kPa	-18kPa	230m ³ /h	< 13kPa	25kg	332x328x358mm
HXB-2200	380v/50Hz	2200w	36kPa	-24kPa	260m ³ /h	< 20kPa	35kg	345x360x371mm
HXB-4000	380v/50Hz	4000w	40kPa	-26kPa	350m ³ /h	< 22kPa	50Kg	434.5x482x440mm



PLATE HEAT EXCHANGER



HVTP-011

1-10M²
1-10M² PLATE TYPE HEAT EXCHANGER

TECHNICAL CHARACTERISTICS

Model	Exchange Area	In/Outlet Water	WxHxThickness	Maximum Weight
HBR005	0.5-5	40	230x580x (158-300)	70
HBR01	2-10	50	320x860x (472-760)	280
HBR02	8-30	65	410x1180x (660-1060)	590
HBR03	10-60	100	490x1420x (730-1400)	1450

PLATE HEAT EXCHANGER



HVTP-010I

I TYPE HEAT EXCHANGER

HVTP-010II

II TYPE HEAT EXCHANGER

HVTP-010III

III TYPE HEAT EXCHANGER

FEATURE

- Heat Exchanges are highly engineered for fast heating, high capacity and easy use.
- High capacity, multi-tubuar heat exchange.
- Primary inlet water circuit(heating agent).
- High efficiency, low energy consumption.

TECHNICAL CHARACTERISTICS

Model	Power (Kw)	Heat Water Flow (l/min)	Cold Water Flow (l/min)	Heat Tranference		Length (mm)	Volume (m ³)
				SQFT	(m ²)		
HMF80	24	20	150	2.0	0.10	310	<30
HMF200	60	30	250	4.6	0.45	590	60-75
HMF400	120	50	360	12.0	1.10	1090	115-175



"3T" WATER HEATER

TECHNICAL CHARACTERISTICS

Item No.	Power (KW)	Inlet/Outlet (Inch)	Voltage (V)	Package (mm) LxWxH
HH-55	5.5	1.5	220/380	500x385x130
HH-75	7.5	1.5	220/380	500x385x130
HH-110	11	1.5	220/380	500x385x130
HH-150	15	1.5	220/380	500x385x130
HH-180	18	1.5	220/380	500x385x130
HH-240	24	2	380	705x390x405
HH-320	32	2	380	705x390x405
HH-360	36	2	380	705x390x405
HH-450	45	2	380	730x400x530
HH-600	60	2	380	730x400x530



HVTP-007
"T" WATER HEATER
5.5-60KW/220V/380V

TECHNICAL CHARACTERISTICS

Item No.	Power (KW)	Inlet/Outlet (Inch)	Voltage (V)	Package (mm) LxWxH
HHS-55	5.5	1.5	220/380	500x385x130
HHS-75	7.5	1.5	220/380	500x385x130
HHS-110	11	1.5	220/380	500x385x130
HHS-150	15	1.5	220/380	500x385x130
HHS-180	18	1.5	220/380	500x385x130
HHS-240	24	2	380	705x390x405
HHS-320	32	2	380	705x390x405
HHS-360	36	2	380	705x390x405
HHS-450	45	2	380	730x400x530
HHS-600	60	2	380	730x400x530



HVTP-006
"T" WATER HEATER
5.5-60KW/220V/380V

COOL MACHINE



2HP/220V
3HP/380V
930x650x960mm

10HP/380V
1450x800x1600mm

8HP/380V
1450x800x1600mm

5HP/380V
1250x650x1080mm



HMD20



HMD50

TECHNICAL CHARACTERISTICS

Model No.	HMD20D	HMD30D	HMD50D	HMD100D	HMD150D	HMD200D
Rated input power (KW)	1.84	2.98	4.6	9.2	11	19
Delivered (KW)	7	14	21	42	50	84
Rated voltage (V)	220	220/380	380	380	380	380
Rated frequency (Hz)	50					
Rated Current (A)	8	13/6	9	18	25	35
Maximum outlet water temperature (°C)	35/45					
Water flow (L/H)	2,000	3,600	5,500	11,000	15,000	22,000
Circulating water pipes (mm)	50	50	50	63	63	75
Dimensions (mm)	1050*350*620	1120*490*710	1120*490*1260	1440*760*1060	1440*760*1060	1990*980*2080
Weight (KG)	75	95	150	300	330	600
Level of security	IPX4					
Electric shock protection grade	One Grade					
Noise (Db)	<40Db	<45Db	<55Db	<60Db	<60Db	-
Refrigerant	R417A/R407C/R22/R404A					
Compressor	-					
Evaporator	Finned heat exchanger					
Condenser	Titanium heat exchanger					
Throttle units	Electric expansion valve					
Defrost	PID defrost, according to the time, fin temperature and environment temperature running state, intelligent defrost					
Control system	Multi-Control					
The test conditions of above parameter	Dry bulb temperature: 20°C Wet bulb temperature: 17°C Inlet water temperature: 15°C					



DEHUMIDIFY UNIT

HDH-504B

- Front air inlet, left side air outlet.
- Defrosting function automatically starts when the ambient temp is below 18°C.
- Intelligent Micro-computer control with Digital Displaying humidity level.
- Four casters make the machine move freely.
- Filter, easy take-down for cleaning.

2.6-3m 40-60m² Applied area: 2.6-3m Height 40-60m²

Voltage / Cycle	Power Input (W)	Compressor	Bucket Capacity (Kg)	Packing Size (mm)	Gross Weight (Kg)
220V/50Hz	920	Rotary	8	530X375X730	32



HDH-504B

HDH-1382B

- Left side air outlet, front air inlet.
- Defrosting function automatically starts when the ambient temp is below 18°C.
- Digital display makes humidity control more freely.
- Four casters make the machine move freely.
- External drainage pipe drains off water continuously.

2.6-3m 140-160m² Applied area: 2.6-3m Height 140-160m²

Voltage / Cycle	Power Input (W)	Compressor	Packing Size (mm)	Gross Weight (Kg)
220V/50Hz	2000	Rotary	710X575X1175	78



HDH-1382B

HDH-1603B

- Upward air outlet, front air inlet.
- Defrosting function automatically starts when the ambient temp is below 18°C.
- Digital display makes humidity control more freely.

2.6-3m 170-200m² Applied area: 2.6-3m Height 170-200m²

Voltage / Cycle	Power Input (W)	Compressor	Packing Size (mm)	Gross Weight (Kg)
220V/50Hz	3220	Rotary	760X565X1910	137



HDH-1603B



HNQ SERIES CHLORINATOR

"HORBO" Saltwater solutions:

Salt chlorinators, are an alternative means of sanitizing your pool with chlorine using the process of electrolysis.

The electrolysis process is achieved by passing the salt water solution through an electrolytic cell which converts sodium chloride (salt) in the water into chlorine gas which, when dissolved in water become sodium hypochlorite (liquid chlorine).

Safe and respecting the environment, this technology brings you:

- Relaxation: Your pool is automatically disinfected.
- Safety: Reduction in chlorine storage and handling.
- Comfort: Clean, safe and crystal-clear water.
- Health and well-being: Therapeutic, saltwater does not irritate eyes and dry out skin.



PRODUCT CHARACTERISTICS

- The chlorine production of HNQ series salt chlorine generator has been improved obviously, and the disinfection of swimming pool is more efficient.
- It can adjust the chlorine production in 6 grades, meet the requirements of swimming pool in different operation periods, save energy and be very environmentally friendly.
- Simple operation, Chinese and English menu function settings, with manual and automatic time control.
- The reactor has the function of forced heat dissipation and automatic reverse pole cleaning. The reactor has the structure of resin protective layer, and the service life of the product is longer.
- HNQ series salt ammonia generator can realize automatic control of swimming pool by uncontrollable circulating water pump (1 set) and underwater lamp (1 set).
- E has the functions of water flow detection, water temperature display, internal overheating protection, salt level prompt, and high-definition OLED display screen.
- There are two optional outlets, which greatly facilitates different management requirements in actual installation.
- Designed removable movable titanium plate structure for easy installation and maintenance.

TECHNICAL CHARACTERISTICS

Model	Dimensions (mm)	(g/h)	Working power supply	(Max)	m ³
HNQ 20	365x260x140	16	AC220-240V/50Hz	250W	≤68
HNQ 30	365x260x140	25	AC220-240V/50Hz	250W	≤105
HNQ 40	365x260x140	33	AC220-240V/50Hz	250W	≤140
HNQ 50	365x260x140	42	AC100-240V/50Hz	250W	≤175



CCOREL 250 SERIES POOL CONTROLLER

HVTP-024
240x200x120mm



SIMPLE TO OPERATE

The CCOREL 250 ORP/PH Digital Controller automatically maintains both sanitizer ORP (oxidation-reduction potential or redox) and water PH in pools and spas. All operating functions are clearly labeled and accessible from the front panel with safety and easy-reset features not found on other controllers. The default PH control level is 7.0. Below 6.9, the water is too acidic and causes corrosion and eye irritation. Above 7.5, it is too alkaline and causes irritation plus water cloudiness, scaling, stains and reduced sanitizer efficiency. The default ORP control level is 650mV, values for prevention of germs and bacteria.

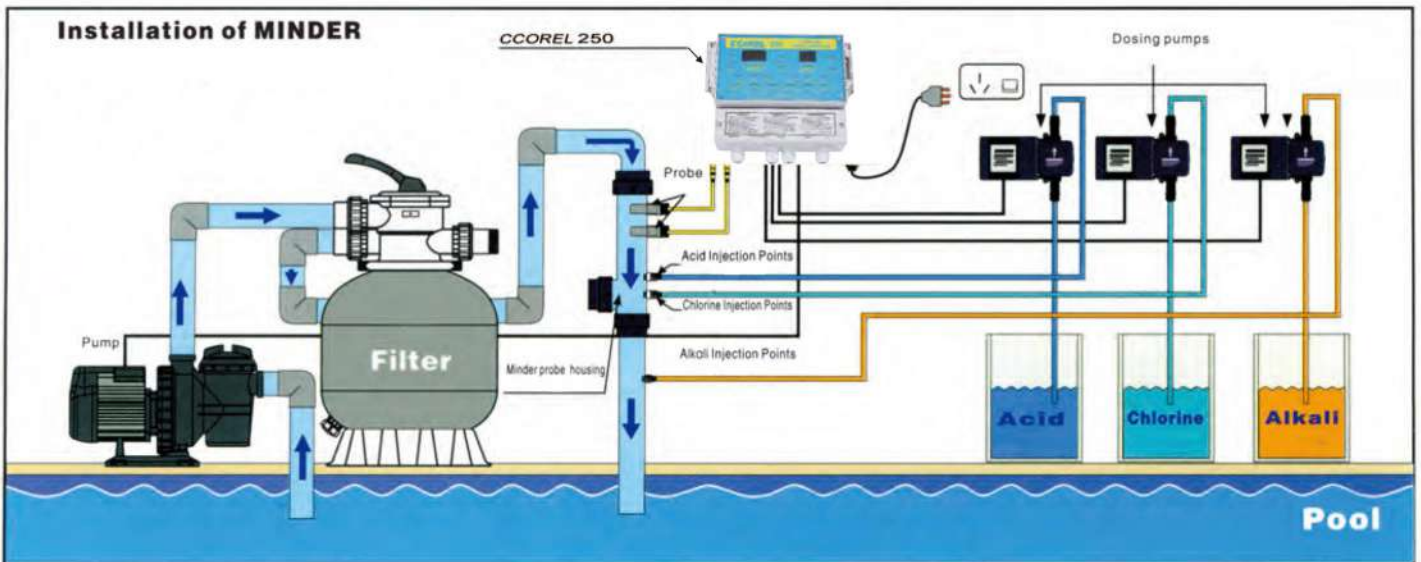



SWIMMING POOL EQUIPMENT



HVTP-004

SIDEKICK-CHLORINE FEEDER

703#
 MAXIMUM PRESSURE: 10 BAR
 FLOW RATE: 9L/H

WORKING TYPE: ELECTRONIC
 VOLTAGE: 220V

803#
 MAXIMUM PRESSURE: 4 BAR
 FLOW RATE: 54L/H

WORKING TYPE: ELECTRONIC
 VOLTAGE: 220V



HVTP-005

**SIDEKICK-CHLORINE FEEDER
 BLUE WHITE**

C-660P
 MAXIMUM PRESSURE: 4 BAR
 FLOW RATE: 13L/H

WORKING TYPE: MECHANICAL
 VOLTAGE: 20V

C-6125P
 MAXIMUM PRESSURE: 2.1 BAR
 FLOW RATE: 30L/H

WORKING TYPE: MECHANICAL
 VOLTAGE: 220V



HVTP-009/HVTP-009A

**CL-100 CL-200
 AUTOMATIC CHOLINE/BROMINE
 OFF-LINE FEEDER**



HVTP-008
 AUTOMATIC CHOLINE/BROMINE
 OFF-LINE FEEDER



HOM-3834
 SUP & BLUE CLARIFIER



HOM-3835
 SUP & BLUE ALGAECIDE



HVTP-027
 CHLORINE OF SANITIZING



HOM-3836
 ALGAECIDE
 (IMPORTED COPPER SULFATE)



HOM-3837
 PH REGULATOR
 25KG



HOM-3838
 PRECIPITATING AGENT
 (ALUMINUM CHLORIDE)



- PVC plastic chamber is compatible for fresh water, sea water, chlorine feeder and salt chlorinator.
- Lamp life : 90Q 0 hours of operation, approximate 12 months of continuous service.
- Ballasts : UL, CUL, TUV-CE listed, LED visual & audible alarm, Overheating protection, Instant start.

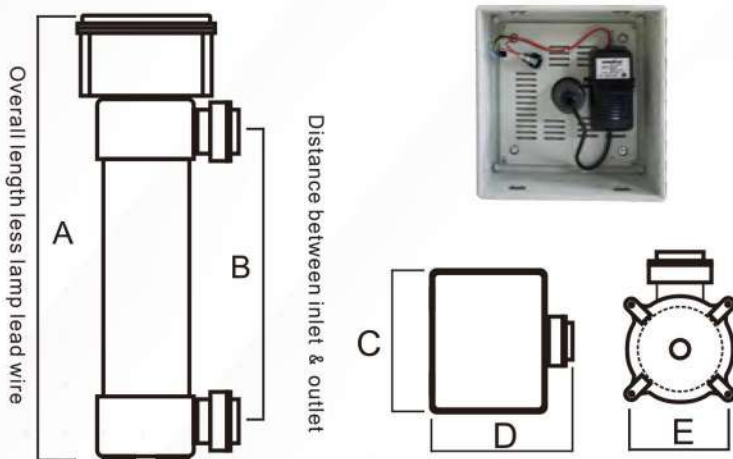

TECHNICAL CHARACTERISTICS

Model	16ml/cm ² UVT=90%	Dimension (mm) A/B/C/D/E/F	Inlet/Outlet Union (Unit. Inch)	UV Lamp	Output Power	Voltage Power	Designed working pressure	Operation Temperature
HPL-I	162GPM (36612LPH)	765/988/219/ 210/351/305	2"	T585	85w	100-240V 50-60Hz	40 Psi	2-40°C
HPL-II	204GPM (46104LPH)	1065/1288/219/ 210/351/305	2"	T5120	120w	100-240V 50-60Hz	40 Psi	2-40°C

UV GERMICIDAL LAMP



HUVF-60

TECHNICAL CHARACTERISTICS

Power of the modulation tube	Wax water flow rate	Water volume	Using frequency	Applications
30W	540	2000	4.5-22 H/EEEEK	Aquarium / Fish pond
40W	740	3000	4.0-20 H/EEEEK	Aquarium / Fish pond
50W	1140	5000	4.25 H/EEEEK	Aquarium / Fish pond
80W	1740	8000	4.0-20 H/EEEEK	Aquarium / Fish pond / pool
160W	3480	16000	2.0-10 H/EEEEK	Aquarium / Fish pond
240W	5220	24000	1.2-8 H/EEEEK	Aquarium / Fish pond



REMOVING ALGAE WITH UV STERILIZER



HUVA 80W-240W	
Water treatment capacity	10T/H
Size	980*110*270mm
Working pressure	<0.8Mpa
Voltage	220v/50Hz
Power	80w-240W
Caliber	DN40 (external thread)
99.9% Bactericidal rate	99.9% Sterilization rate

HUVF 360W-2160W	
Water treatment capacity	40T/H
Size	1280*165*430mm
Working pressure	<0.8Mpa
Voltage	220v/50Hz
Power	360w~2160W
Caliber	DN80 (external thread)
99.9% Bactericidal rate	99.9% Sterilization rate

OZONE GENERATOR



Main application :

Ozone generator is mainly used in medicine, water, pure water, mineral water, secondary water supply, swimming pool, aquaculture water, food and beverage industries such as water disinfection essence processing, and chemical industry, papermaking industry such as degreasing, bleaching, for life, industry, hospital sewage treatment (sterilization, remove BOD, COD, etc.), as well as the life sewage, industrial cooling water reuse treatment, etc.

Model	Product	LxWxH	Ozone Output	Voltage	Weight (Kg)	Power	
HHY-013	Ozone	80x55x130	80g/h	220V/50Hz	40	1000	
			100g/h		60	1300	
			120g/h		65	1500	
HHY-004	Ozone	32x25x82	5g/h		11	160	
			10g/h		13	180	
HHY-003	Ozone`	40x30x93	20g/h		25	380	
			40g/h		30	400	
Max. Ozone Density							
Max. Ozone Density			80-100mg/L Oxygen Source: 80-100mg/L			15-20mg/L Dry air Source: 15-20mg/L	



HORBO POOL AND SPA ACCESSORIES





HVTP-325
φ150 WIND TYPE SWIM LANE LINE



HVTP-326
SPIRAL ARC SWIMMING POOL LANE ROPE



HVTP-327
φ110 NORMAL SWIMMING POOL LANE ROPE



HVTP-328
φ120 SIX ROWED SWIMMING POOL LANE ROPE



HVTP-330
φ110 CIRCLE SWIMMING POOL LANE ROPE



SAFE FLOAT LINE



HVTP-365
HOOK



HVTP-366
HOOK



HVTP-364
EMBEDDED CUP



HVTP-316
HVTP-316



HVTP-332
LIFE CLOTHE



HVTP-333
LIFE CLOTHE



LIFE-GAURD CHAIR
1900X900X800MM



LIFE-GAURD CHAIR
1900X900X800MM



HVTP-315
LANE LINE REEL
SIZE: 150X980X108MM



POOL AND SPA ACCESSORIES

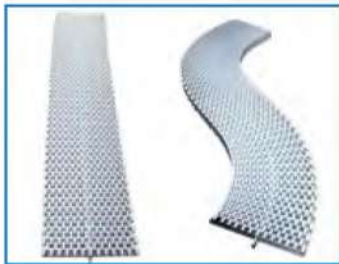

HVTP-602
18/25/30 CM



HVTP-604
18/20/25/30 CM



HVTP-605
18/20/25/30 CM



HVTP-607
18/25/30 CM



HVTP-609
ABS 18/25/30 CM



HVTP-613
30/35/40 CM



HVTP-610
18/20/25 CM



HVTP-617

ALUMINIUM ALLOY GRATINGS

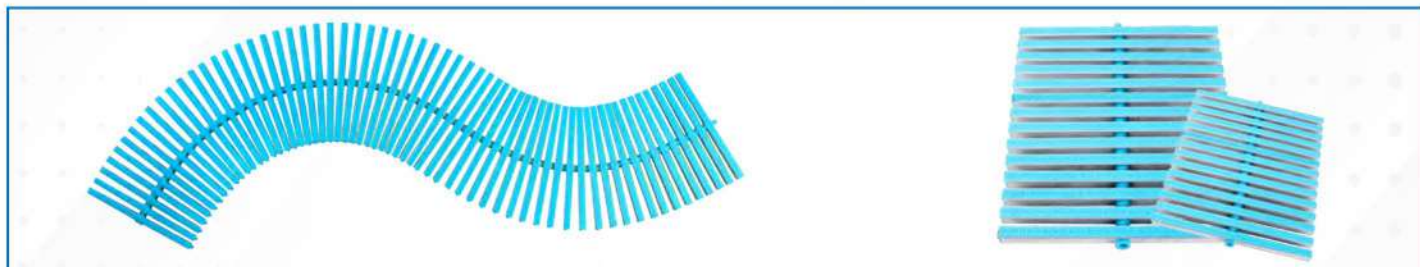

HVTP-616
18/20/25/30 CM

POOL DEPARTURE PLATFORM

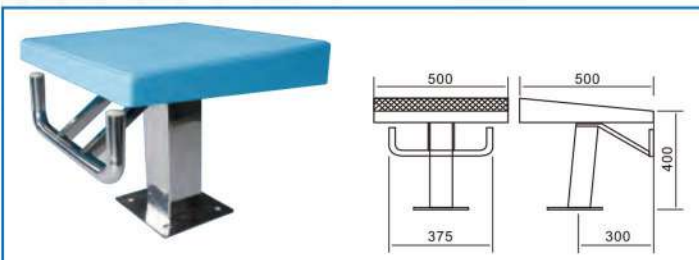

HVTP-303
STANDARD ONE-STEP STARTING BLOCK

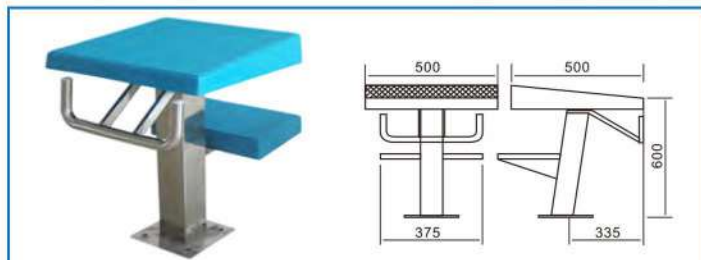

HVTP-305
STANDARD TWO-STEP STARTING BLOCK

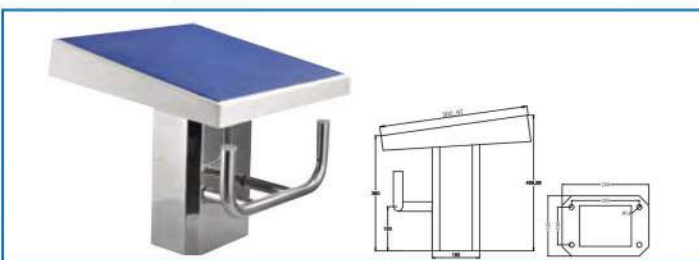

HVTP-301
STANDARD ONE-STEP STARTING BLOCK



HVTP-3011
STANDARD ONE-STEP STARTING BLOCK

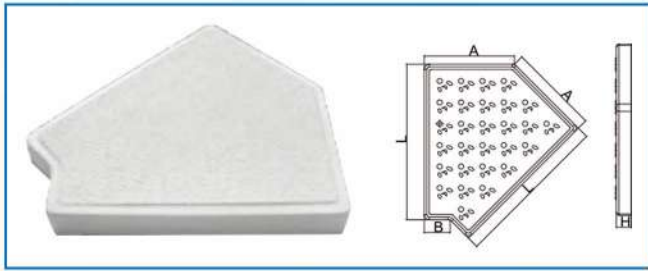

Model No.	Specification
HFT 3045	300-45°Fiberglass Corner Tile (White)
HFT 2545	250-45°Fiberglass Corner Tile (White)
HFT 2045	200-45°Fiberglass Corner Tile (White)

45°CORNER TILE FOR GRATING

Model	A	B	H	L
HFT 3045	174	50	28.5	300
HFT 2545	154	50	28.5	250
HFT 2045	133	50	28.5	200

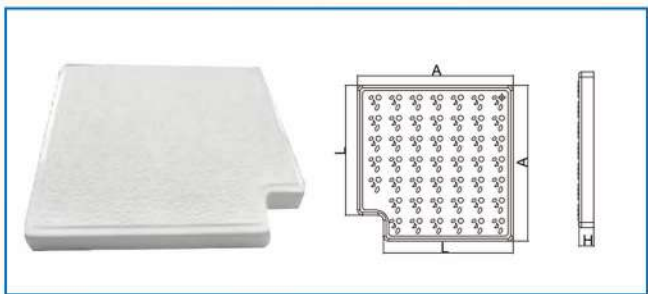

Model No.	Specification
HFT3030	300-90°Fiberglass Corner Tile (White)
HFT2590	250-90°Fiberglass Corner Tile (White)
HFT2090	200-90°Fiberglass Corner Tile (White)

90°CORNER TILE FOR GRATING

Model	A	H	L
HFT3030	350	28.5	300
HFT2590	300	28.5	250
HFT2090	250	28.5	200

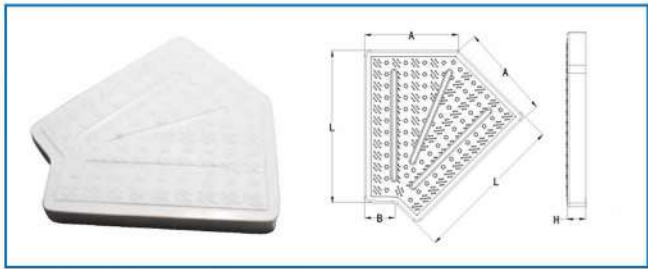

Model No.	Specification
HPT 3045	300-45°Fiberglass Corner Tile (White)
HPT 2545	250-45°Fiberglass Corner Tile (White)
HPT 2045	200-45°Fiberglass Corner Tile (White)

NEW 45°CORNER TILE FOR GRATING

Model	A	B	H	L
HPT 3045	174	50	28.5	300
HPT 2545	154	50	28.5	250
HPT 2045	133	50	28.5	200



Model No.	Specification
HFT3030	300-90°Fiberglass Corner Tile (White)
HFT2590	250-90°Fiberglass Corner Tile (White)
HFT2090	200-90°Fiberglass Corner Tile (White)

NEW 90°CORNER TILE FOR GRATING

Model	A	H	L
HPT3090	350	28.5	300
HPT2590	300	28.5	250
HPT2090	250	28.5	200



POOL AND SPA ACCESSORIES

SKIMMER

Model No.	Colour	Material
HSP0030C	White	ABS+UV

SKIMMER

Model No.	Colour	Material
HSP0030V	White	ABS+UV

SKIMMER

Model No.	Colour	Material
HSP0040C	White	ABS+UV

SKIMMER

Model No.	Colour	Material
HSP0040V	White	ABS+UV

MAIN DRAIN (FOR VINYL POOL)

Model No.	Colour	Material
HSP2850V	White	ABS+UV

MAIN DRAIN (FOR CONCRETE POOL)

Model No.	Colour	Material
HSP2850C	White	ABS+UV

OUTLET FITTING

Model No.	Colour	Material	Connection
HSP2851	White	ABS+UV	1.5 interpolation 2" external

OUTLET FITTING

Model No.	Colour	Material	Connection
HSP2852	White	ABS+UV	1.5

SUCTION NOZZLE

Model No.	Colour	Material	Connection
HSP2853	White	ABS+UV	1.5 interpolation 2" external

SUCTION NOZZLE

Model No.	Colour	Material	Connection
HSP2854	White	ABS+UV	1.5



POOL AND SPA ACCESSORIES

VACUUM FITING (FOR VINYL POOL)

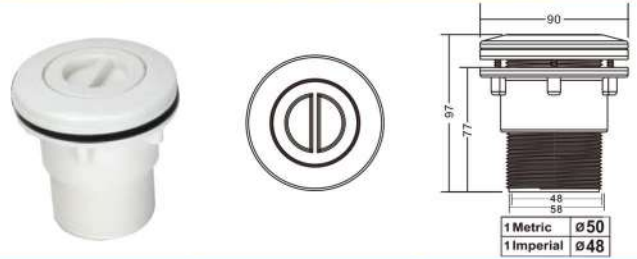

Model No.	Colour	Material
HSP2827V	White	ABS+UV & PVC

WALL INLET (FOR VINYL POOL)

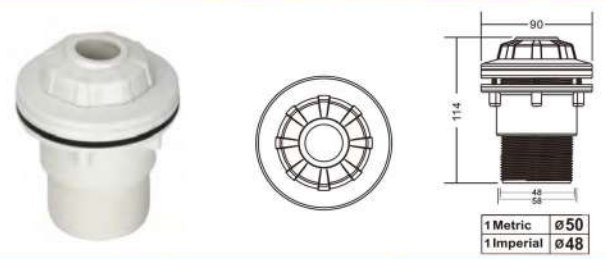

Model No.	Colour	Material
HSP2828V	White	ABS+UV & PVC

WALL RETURN (FOR VINYL POOL)



Model No.	Colour	Material
HSP2829V	White	ABS+UV & PVC

OUTLET FITTING (FOR VINYL POOL)



Model No.	Colour	Material
HSP1006V	White	ABS+PVC

WALL RETURN

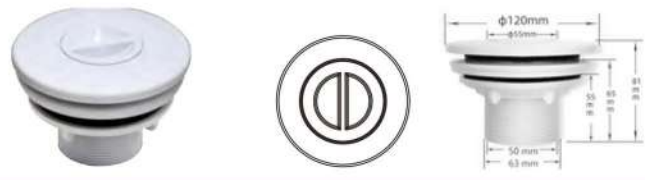

Model No.	Colour	Material
HSP1007V	White	ABS+UV & PVC

WALL RETURN



Model No.	Colour	Material
HSP1008V	White	ABS+UV & PVC

MAIN DRAIN



Model No.	Colour	Material
HSP1423	White	ABS+PVC

OUT/INLET FITTING



Model No.	Colour	Material
HSP1425	White	ABS

SUCTION FITTING

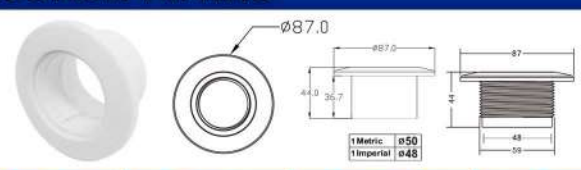

Model No.	Colour	Material	Size
HSP1022	White	ABS+UV	1.5"
HSP1022	White	ABS+UV	2" thread

COVER OF SUCTION FITTING

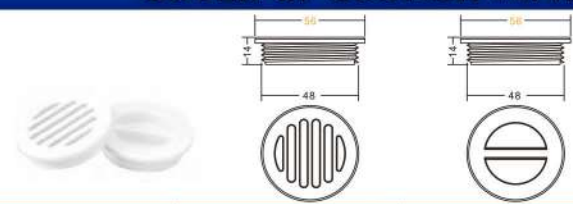

Model No.	Colour	Material
HSP1022A	White	ABS+UV
HSP1022B	White	ABS+UV



POOL AND SPA ACCESSORIES

MESSAGE JET

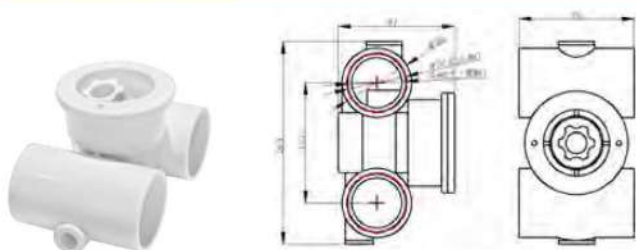

Model No.	Colour	Material
HSP-1434	White	ABS+UV

MESSAGE JET-STAINLESS

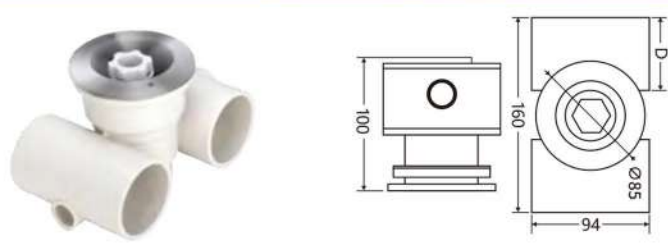

Model No.	Colour	Material
HSP-1434S	White	SS304+ABS

EYE BALL SKT

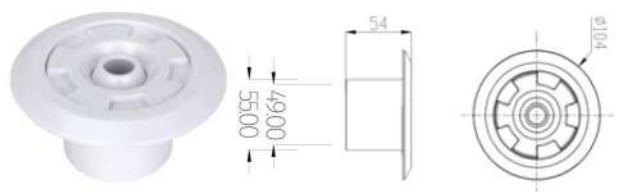

Model No.	Colour	Size	Material
HSP1432	White	DN50/DN63	ABS

WATER RETURN

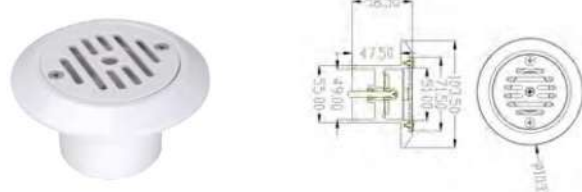

Model No.	Colour	Size	Material
HSP1433	White	DN50/DN63	ABS

GUTTER DRAIN

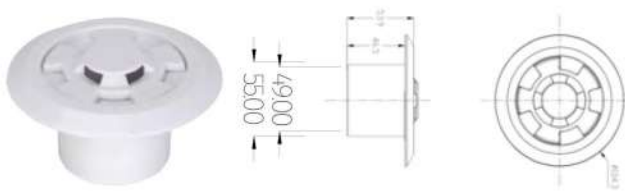

Model No.	Colour	Size	Material
HSP1435	White	DN50/DN63	ABS

EYE BALL SKT

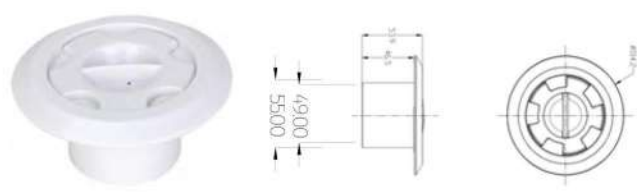

Model No.	Colour	Size	Material
HSP1436	White	DN50/DN63	ABS

GUTTER DRAIN

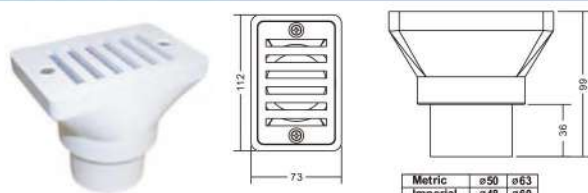

Model No.	Colour	Material
HSP-2819	White	ABS+UV & PVC

WALL RETURN

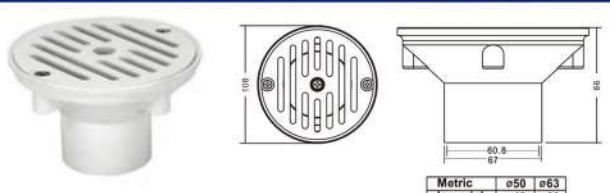

Model No.	Colour	Material
HSP-2824	White	ABS+UV & PVC

MAIN DRAIN

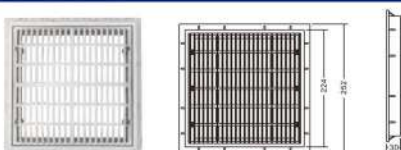

Model No.	Colour	Material	Specification
HSP1031	White	ABS	9"x9"
HSP1032	White	ABS	12"x12"

MAIN DRAIN

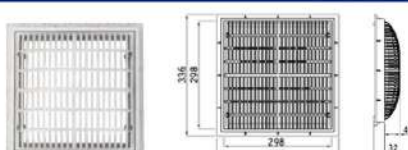

Model No.	Colour	Material	Specification
HSP1035	White	ABS	9"x9"
HSP1036	White	ABS	12"x12"

SPRAY NOZZLE

Model No.	Colour	Size	Material
HPL-1419B	White	1.5"/10mm	ABS+UV

SPRAY NOZZLE

Model No.	Colour	Size	Material
HP-1419C	White	1.5"/12.5mm	ABS+UV

SUCCESSIVE SPRAY NOZZLE

Model No.	Specification
HSP2856	Grey 1.5

SPRAY NOZZLE

Model No.	Colour	Material
HSP1450T	White	ABS

HSP-0022
SS SUCTION NOZZLE (SCREW)

HSP-0024
SS SUCTION RETURN (SCREW)

HSP-0029
SS GUTTER DRAIN (SCREW)

HSP-0030
COPPER FLOOR DRAIN

HSP-1030S
MAIN DRAIN

HSP-1031S
MAIN DRAIN

HSP-0022A
MOTOR PNEUMATIC SWITCH

HSP-0022
PLASTIC CHROME PLATING SWITCH

HSP-0023
PLASTIC ADJUST SWITCH



POOL AND SPA ACCESSORIES



HB-158
CONNECTOR
WHITE 3/4"



HF03
TEE
SIZE: DN50, DN63 SOCKET



HF09-90
DEGREE ELBOW
SIZE: DN50, DN63 SOCKET



HN103
1.5"/2"



HN102
2"-15"/1.5"-1"



HN101
1.5" / 2"



HF71
DOUBLE UNION BALL VALVE
SIZE: 1/2" TO 4" THREAD, SOCKET
1/2"-2": 235PSI MAX.
2-1/2"-4": 150PSI MAX.



HF61
SINGLE UNION BALL VALVE
SIZE: 1/2" TO 2" THREAD, SOCKET
235PSI MAX



HA-127
NON-RETURN VALVE
WHITE 2"



HA-128
NON-RETURN VALVE



HF-62



HH201
ONE-WAY THREAD UNION



NON-0324



ANCHOR TYPE



HN104
PVC
2"/1.5"/1"



HSP1068
CHECK VALVE



HSP1030
MAIN DRAIN



HSP-1096
SKIMMER



HSP-2855
DISCHARGE JET



PUMP CONNECTION



HORBO PLASTIC FILM KEEPS YOUR SWIMMING POOL LEAK PROOF FOR 5 YEARS

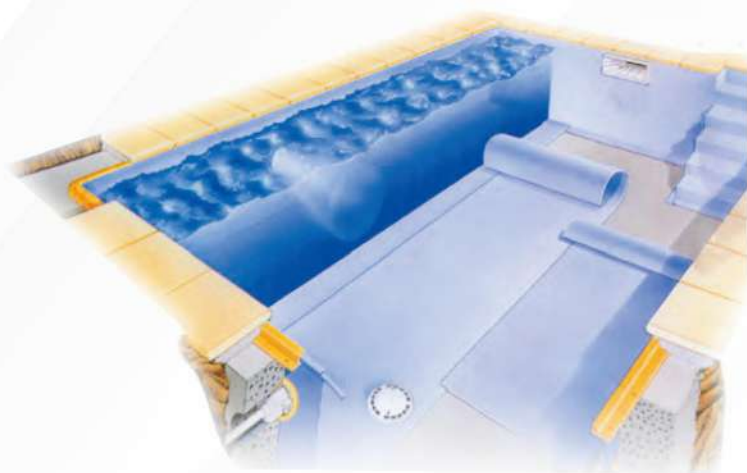

Non-Slip Vinyl Liner

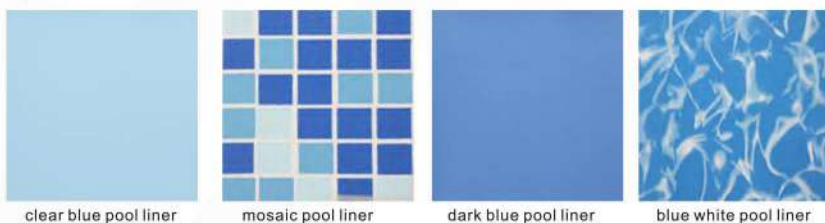

MODEL	SIZE	THICKNESS
clear blue pool liner	2x25 (40) m	1.2mm
mosaic pool liner	1.83x25 (40) m	1.5mm
dark blue pool liner	1.83x25 (40) m	1.5mm
blue white pool liner	1.83x25 (40) m	1.5mm

Instruction:

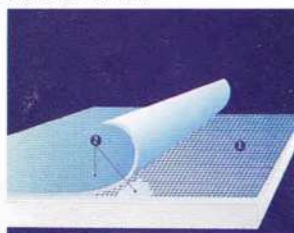

1. Inner Frame Of Polyester Weft
2. Highly Resistant PVC

Installation details :

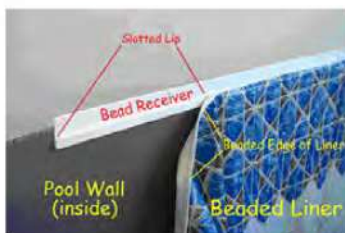

REMARK

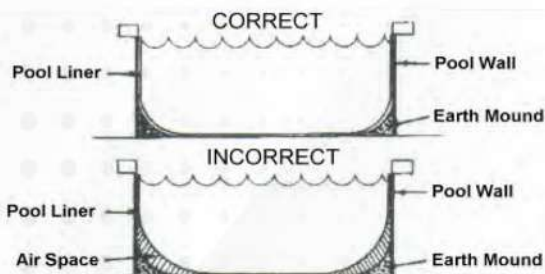

Failure to follow installation instructions will damage the pool liner and void the warranty

Ideal for residential pools. Manufactured in reinforced PVC-P, this materials is the most useful for lining pools thanks to enhanced malleability, resistance to tearing , ease of welding, resistance to discoloration by UV rays and with a wide range od available colors.

Made-to-measure liners are put together by high frequency welding machines at our facilities. Perfectly adaptable to any pool design or shape, with excellent watertight features, so you can forget about annoying leaks.

*Ensures total watertightness in odd shaped pools or pools with numerous steps. *Highly flexible and adaptable.

- *Smooth and pleasant to touch, it is easy to maintain and durable.
- *Highly resistant to impacts and tearing.
- *PVC does not release dioxins into the atmosphere and can be recycled.
- *Compatible with concrete, prefabricated or steel panel pools. Can also be installed in pools with overflow.



HORBO LADDER SERIES



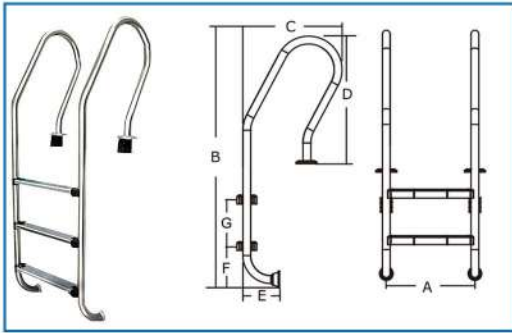

HSF LADDER							
Model	A mm	B mm	C mm	D mm	E mm	F mm	G mm
HSF-215	502	1330	650	640	180	200	250
HSF-315	502	1580	650	640	180	200	250
HSF-415	502	1830	650	640	180	200	250
HSF-515	502	2080	650	640	180	200	250

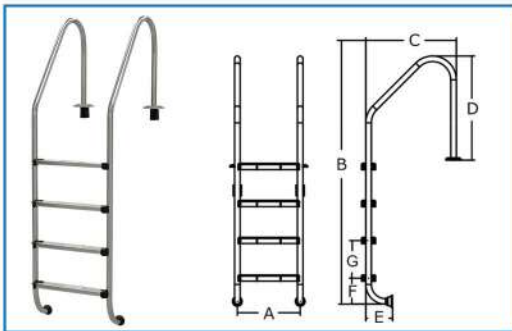

HSL LADDER							
Model	A mm	B mm	C mm	D mm	E mm	F mm	G mm
HSL-215	502	1330	650	640	180	200	250
HSL-315	502	1580	650	640	180	200	250
HSL-415	502	1830	650	640	180	200	250
HSL-515	502	2080	650	640	180	200	250

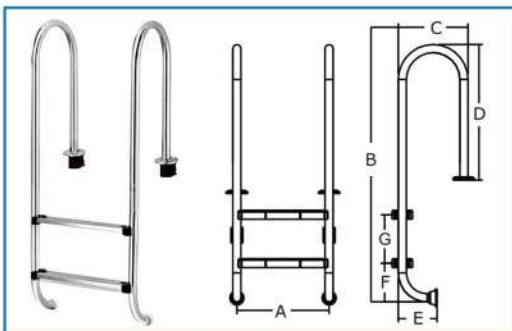

HMU LADDER							
Model	A mm	B mm	C mm	D mm	E mm	F mm	G mm
HMU-215	502	1330	365	640	180	200	250
HMU-315	502	1580	365	640	180	200	250
HMU-415	502	1830	365	640	180	200	250
HMU-515	502	2080	365	640	180	200	250

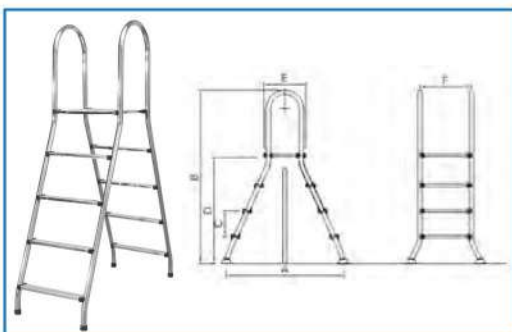

HSP LADDER							
Item No	Step	A mm	B mm	C mm	D mm	E mm	F mm
HSP2+2	2+2	1150	1380	250	730	420	500
HSP3+3	3+3	1150	1580	250	930	420	500
HSP4+4	4+4	1360	1880	250	1230	420	500
HSP4+4	4+4	1360	1900	250	1350	420	500
HSP5+5	5+5	1700	2120	250	1530	420	500



STAINLESS STEEL STEP



STAINLESS STEEL STEP WITH ANTI SLIP



ANCHOR TYPE



FLANGE TYPE

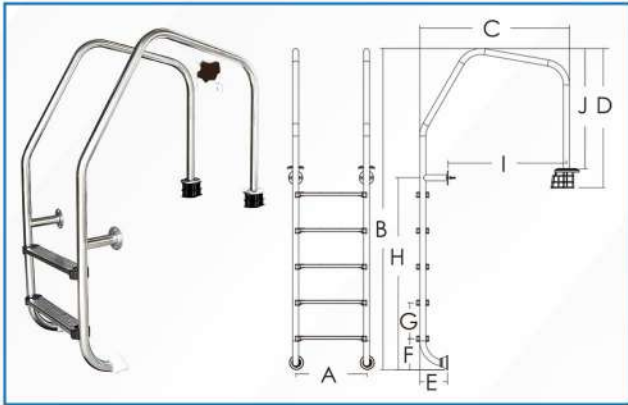

HLF LADDER										
Model	A mm	B mm	C mm	D mm	E mm	F mm	G mm	H mm	I mm	J mm
HLF215	493	1460	1042	830	190	200	250	561	831	750
HLF315	493	1710	1042	830	190	200	250	811	831	750
HLF415	493	1960	1042	830	190	200	250	1061	831	750
HLF515	493	2210	1042	830	190	200	250	1311	831	750



With polished Stainless Steel pipe ($\phi 42\text{mm}$), this ladder is specially designed for over flow pool with attractive appearance. Easily installed with anchoring or flange fixtures.

HANDRAIL COMPONENT

The following components are for the installation of grad rails around the edge of the pool.



Straight handrails

Polished Stainless Steel AISI 304 or AISI 316.
Handrail length in 1m.

Model: With AISI-304 With AISI-316



End Cup

Polished Stainless Steel AISI 304 or AISI 316.
For the end of $\phi 42\text{mm}$ pipe.

Model: With AISI-304 With AISI-316



Straight bracket with base plate

Polished Stainless Steel AISI 304 or AISI 316.
Applicable for both concrete pool and vinyl pool.

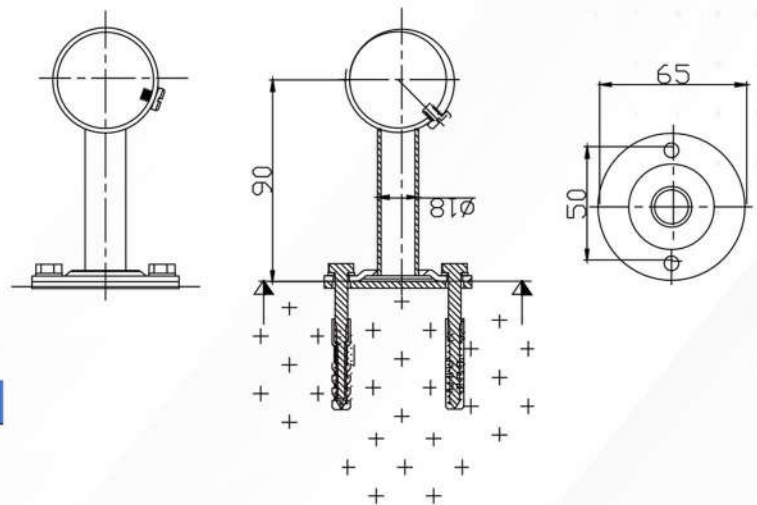

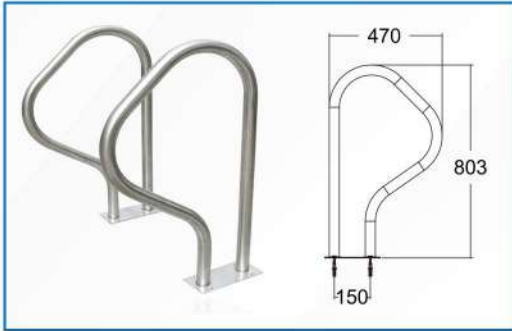

HARB SERIES

Model	Description
HARB-F	Exit Handrail
HARB-F	Exit Handrail

Polished AISI 304 or AISI 316 Stainless Steel (ϕ 42mm) pipe. Both anchor and

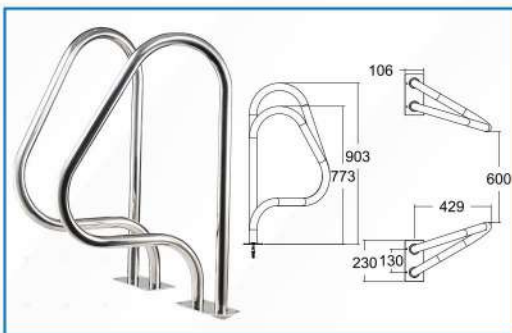

HARC SERIES

Model	Description
HARC	Exit Handrail
HARC	Exit Handrail

Polished AISI 304 or AISI 316 Stainless Steel (ϕ 42mm) pipe. Both anchor and flange installations are available.

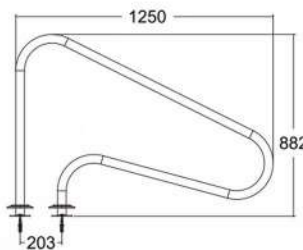
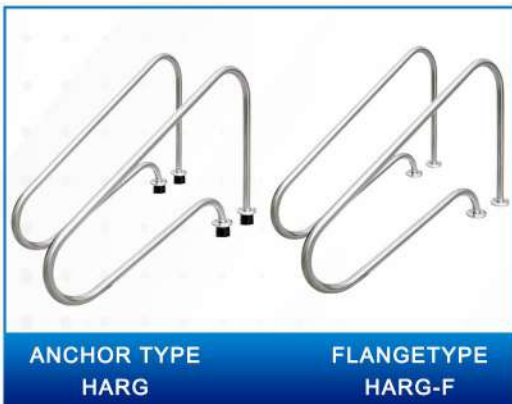

HARG SERIES

Model	Model	Description
HARG	HARG-F	Exit Handrail
HARG	HARG-F	Exit Handrail

Polished AISI 304 or AISI 316 Stainless Steel (ϕ 42mm)pipe. Both anchor and flange installations are available.

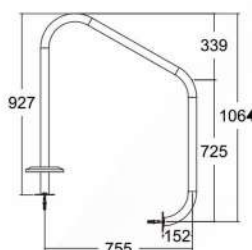

HARS SERIES

Model	Model	Description
HARS	HARS-F	Exit Handrail
HARS	HARS-F	Exit Handrail

Polished AISI 304 or AISI 316 Stainless Steel (ϕ 42mm)pipe. Both anchor and flange installations are available.

HORBO CLEANING EQUIPMENT





CLEANING EQUIPMENT



H3002

H3002 SUPER EDITION
CABLE LENGTH 30 METERS
CYCLE TIME: 4/6/8 HOURS



DOLPHIN H3002# CLEANER ROBOT

CABLE LENGTH 30M, REMOTE CONTROL,
PROGRAMMABLE, CLIMB WALL



H2V

DOLPHIN 2X2# CLEANER ROBOT
CABLE LENGTH 45M, REMOTE CONTROL,
PROGRAMMABLE, CLIMB WALL,
BEST CHOICE FOR OLYMPIC POOL



HHJ-2042L

AUTOMATIC POOL CLEANER



HPAC-08

AUTOMATIC POOL CLEANER
CA REQUIRES A PUMP OF MINIMUM 0.75HP/550W
(OR MINIMUM FLOW OF 6.5M3/HR/1700GAL/HR)



HVTP-51

MANUAL POOL CLEANER



HVTP-050

SS CLEANING CAR

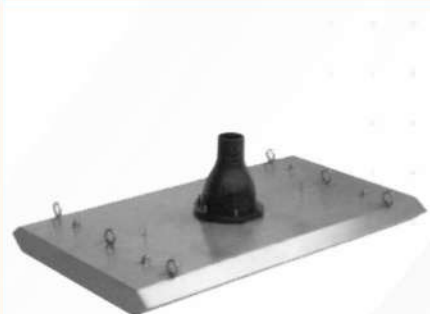

HVTP-336

SS VACCUUM HEAD
1000X350MM



CLEANING EQUIPMENT



HPVH-01
TRIANGULAR LINER VAC HEAD W SWIVEL CUFF



HPVH-06
DELUXE TRIANGULAR TRANSPARENT CAST IRON WEIGHTED VAC HEAD



HPVH-07
VAC HEAD W/SIDE BRUSHES



HPVH-03
VAC HEAD BRUSHES



HPVH-09
FLEXIBLE VAC HEAD W SWIVEL BRUSH FOR IG POOL



HPVH-08
FLEXIBLE VAC HEAD FOR IN-GROUND POOL



HPV-05
14-19" VACUUM HEAD

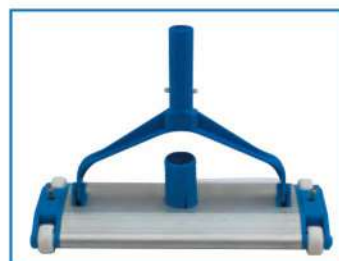

HPV-03
14-19" VACUUM HEAD



HPVH-17
DELUXE VACUUM BRUSH W/EASY BUTTON



HPVH-18
DELUXE VACUUM HEAD W TRANSPARENT COVER & EASY BUTTON



HPVH-16
DELUXE PENTAGONAL VACUUM HEAD W/EASY BUTTON



HPVH-20
14-19" ALUMINIUM FOLDING VACUUM HEAD W/4 FOLDING PANELS



HPLS-02
PROFESSIONAL ALUMINIUM LEAF SKIMMER



HPLS-1001
DELUXE LEAF SKIMMER W/EASY BUTTON



HPDRS-1001
DELUXE DEEP RAKE W/EASY BUTTON



HPDRS-05
PROFESSIONAL HEAVY DUTY DEEP RAKE W/ALU FRAME



HPDRS-10
PROFESSIONAL DELUXE DEEP RAKE W/SQUEEGEE STRIP AND REPLACEABLE NET



HPLS-01
STANDARD LEAF SKIMMER (BLUE)



HPDRS-04
ECONOMY DEEP BAG RAKE



HPDRS-01
HEAVY DUTY PLASTIC LEAF RAKE WITH LONG WEARING SCREEN MESH



HPLS-03
HEAVY DUTY PLASTIC LEAF SKIMMER (BLUE)



HPLSH-02
LEAF SKIMMER WITH 48"/122CM ALUMINIUM POLE

 <p>HPB-04 OVERSIZED POLYBRISTLE WALL BRUSH W/EZ-CLIP</p>	 <p>HPB-11 18"/45CM METAL BACK WALL BRUSH</p>	 <p>HPB-08 18"/45CM STAINLESS STEEL ALGAE BRUSH</p>	 <p>HPB-02 PROFESSIONAL HEAVY DUTY DEEP RAKE W/ALU FRAME</p>	 <p>HPB-03 FLEXIBLE BRUSH W/ ALU HANDLE & EXTRA BRISTLES</p>
--	---	---	---	--

 <p>HPB-05 10"/26CM POLYBRISTLE WALL BRUSH</p>	 <p>HPB-06 10"/26CM STAINLESS STEEL ALGAE BRUSH</p>	 <p>HPB-07 10"/26CM STAINLESS STEEL ALGAE BRUSH</p>	 <p>HPD-01 DELUXE LARGE CHEMICAL DISPENSER FOR 3" TABLETS</p>	 <p>HPT-13 LARGE SCALE FLOATING DIAL THERMOMETER</p>
---	---	---	--	--

 <p>HPT-05 DELUXE ROUND THERMOMETER W/STRING</p>	 <p>HPT-08 JIM BUOY THERMOMETER W/STRING</p>	 <p>HPT-11 FLOATING ANIMAL THERMOMETER IN 4 STYLES</p>	 <p>ELECTRONIC TESTER</p>	 <p>HPTK-02 PH.OTO</p>
--	---	---	---	---

 <p>HPTK-01 BASIC PH & CI TEST KIT(20CC)</p>	 <p>HPTK-05 5-WAY TEST KIT (PH/CI/ALKALINITY/ ACID DEMAND/BROMINE)</p>	 <p>HVTP-360 TELESCOPIC POLE 3M/5M/7M/8M/9M</p>	 <p>HVTP-361 LIFE SAVING HOOK</p>
---	--	--	---

 <p>HPHR-01 HOSE REEL WITHOUT HOSE</p>	 <p>HVTP-362 VACUUM HOSE 9/12/15/30</p>	 <p>HVTP-363 VACUUM HOSE 9/12/15/30</p>	 <p>HVTP-364 VACUUM HOSE 2'10</p>
---	---	--	---



HPCR-01
IN-GROUND POOL COVER REEL W/
SS FRAME FOR 3/4" TUBES



HPCR-02
ABOVE GROUND POOL COVER REEL W/
ABS FRAME FOR 3/4" & 1-1/2" TUBES



CERAMICS

Swimming pool tiles are a special high-tech product, available in two types: glazed flat surface and body-colored corrugated surface, with complete specifications and perfect matching. The glaze comes in various colors such as black, white, blue and so on. It is crystal clear and clean, and the corrugated surface has the characteristics of simple and elegant material, non-slip and wear resistance. Designed for long-term immersion in water in swimming pools, it has water pressure resistance, corrosion resistance, excellent hot and cold physical properties, and no chemical reaction to human skin.

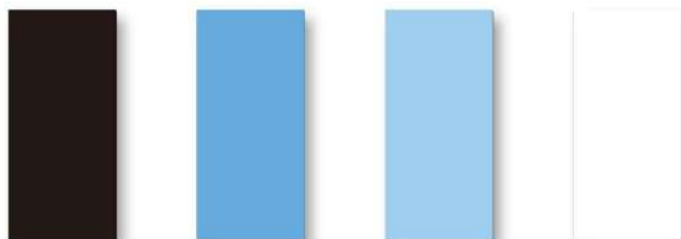

HYCS-201 HYCS-202 HYCS-203 HYCS-204



HYCS-205 HYCS-206 HYCS-207 HYCS-208 HYCS-209

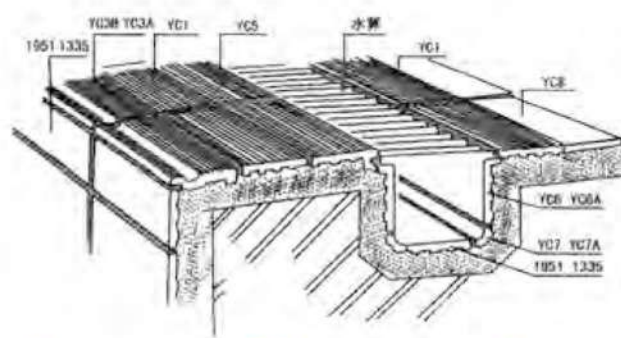

HYCS-210 HYCS-211 HYCS-212 HYCS-213 HYCS-214 HYCS-215



HPY-48704 HPY-48602 HPY-4861 HPY-48V02 HPY-48603



HORBO

SAUNA SERIES





After enjoying sauna, you will find that you're relaxed, your body and brain is disentangled from the boring work and saily vexation. Tired, headache has gone with the heat. For the busy modern live, it's a good way for you to relax yourself.

6mm Tempered Glass Secured Door Bronze Colour With magnet handle

Thermo-Hidrometer

Sauna Wooden Floor

Special spruce wood with glass wool isolation wall panes 7.5cm



Sandglass

Suitable Heater

Spruce Benches





HM-2020
2000X2000X2100MM



HD-1815
1800X1500X2100MM



HK-2015
2000X1500X2100MM



HE-2018
2000X1800X2100MM



HA-1212
1200X1200X2100MM



HH-3025
3000X2500X2100MM





HKP-01
1100X1200X2100MM

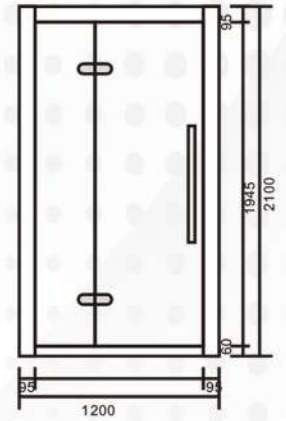
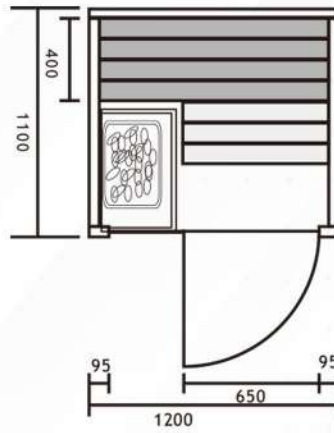

HKP-02
1500X1800X2100MM

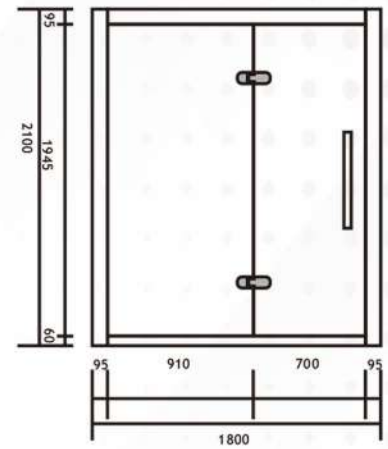
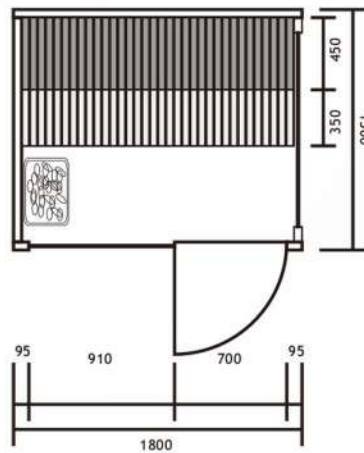

HKP-03
2000X2000X2100MM

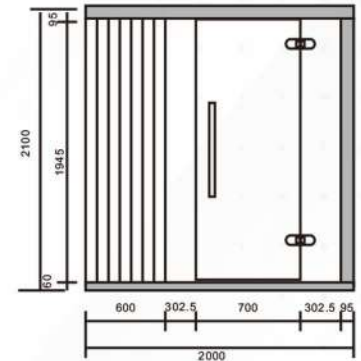
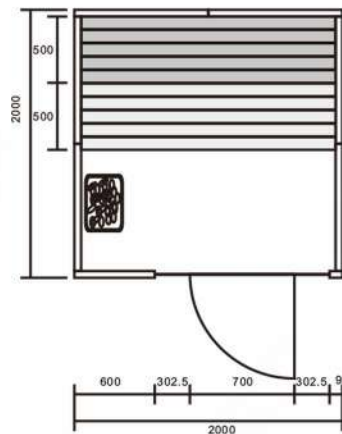

HKP-04
2000X2000X2100MM

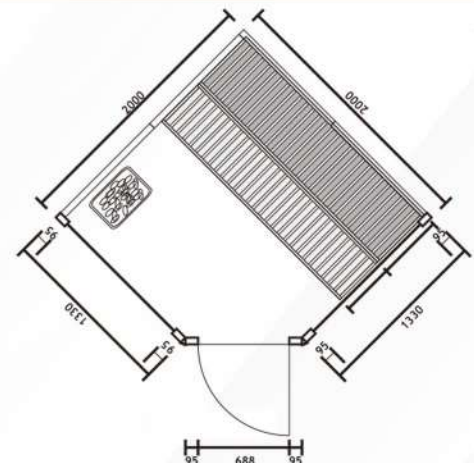



HKV-AC100
900X900X1900MM



HKV-AC200
1200X1000X1900MM



HKV-AC320
1300X1200X2000MM



HKV-AC300
1500X1000X1900MM



HKV-AC400
1800X1200X1900MM

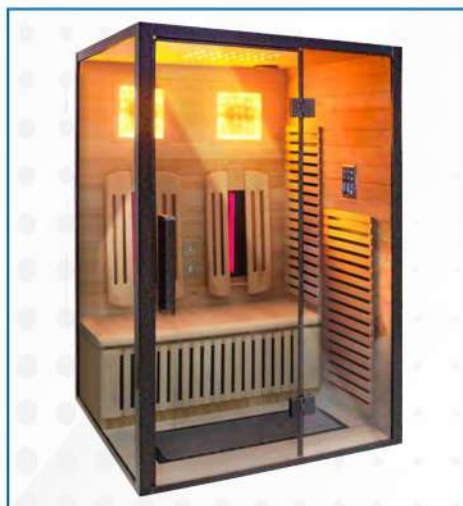

HKV-AC500
1200X1300X2000MM





FARIN FFRARED SWEAT STREAM ROOM SERIES				
Model	HKN-001A	HKN-002A	HKN-003A	HKN-004A
Size	90x95x190cm	120x105x190cm	150x115x190cm	180x125x190cm
Voltage	110v/220v	110v/220v	110v/220v	110v/220v
Power	1400w	1700w	2100w	2600w
Material	Spruce wood		Cedar wood	



FARIN FFRARED SWEAT STREAM ROOM SERIES				
Model	HKN-001B	HKN-002B	HKN-003B	HKN-004B
Size	90x95x190cm	120x105x190cm	150x115x190cm	180x125x190cm
Voltage	110v/220v	110v/220v	110v/220v	110v/220v
Power	1400w	1700w	2100w	2600w
Material	Spruce wood		Cedar wood	



FARIN FFRARED SWEAT STREAM ROOM SERIES				
Model	HKN-001C	HKN-002C	HKN-003C	HKN-004C
Size	90x95x190cm	120x105x190cm	150x115x190cm	180x125x190cm
Voltage	110v/220v	110v/220v	110v/220v	110v/220v
Power	1400w	1700w	2100w	2600w
Material	Spruce wood		Cedar wood	



FARIN FFRARED SWEAT STREAM ROOM SERIES				
Model	HKN-001H	HKN-002H	HKN-003H	HKN-004H
Size	90x95x190cm	120x105x190cm	150x115x190cm	180x125x190cm
Voltage	110v/220v	110v/220v	110v/220v	110v/220v
Power	1400w	1700w	2100w	2600w
Material	Cedar wood			



Installation dimension

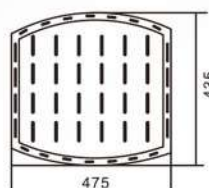
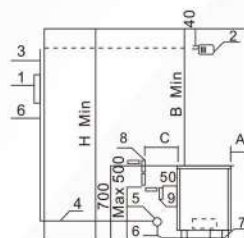

MODEL	Power (KW)	Sauna room			Min.Distance to heater		
		Min.Capacity	Max.Capacity	Height	Min.A from side wall to back wall	Min.Suspension ceiling	Min.B for guard bar and upper stool
HH-105	10.5	9	15	190	12	120	15
HH-135	13.5	11	20	210	16	140	20
HH-165	16.5	16	25	210	16	140	20

Technical Characteristics

Model	Power	Applicable space (m ³)
HH-105	10.5KW	9-15
HH-135	13.5KW	10-18
HH-165	16.5KW	14-24



Installation dimension

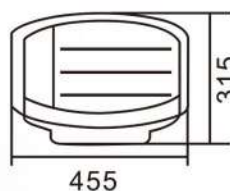
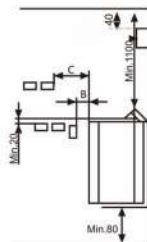
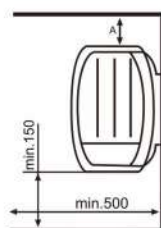

Sauna Heater Distance	4.5KW	6KW	8KW	9KW
A (mm)	35	50	100	120
B (mm)	20	30	30	40
C (mm)	35	50	80	100

Technical Characteristics

Model	Power	Applicable space (m ³)
HH-45B	4.5KW	3-6
HH-60B	6.0KW	5-9
HH-80B	8.0KW	8-12
HH-90B	9.0KW	9-13



Installation dimension

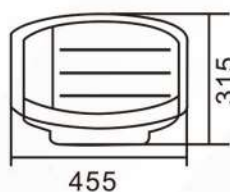
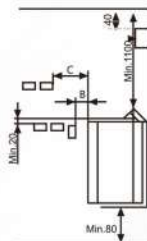
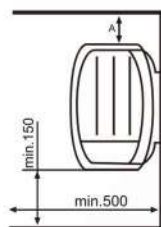

Sauna Heater Distance	4.5KW	6KW	8KW	9KW
A (mm)	35	50	100	120
B (mm)	20	30	30	40
C (mm)	35	50	80	100

Technical Characteristics

Model	Power	Applicable space (m ³)
HH-45BS	4.5KW	3-6
HH-60BS	6.0KW	5-9
HH-80BS	8.0KW	8-12
HH-90BS	9.0KW	9-13

Installation dimension

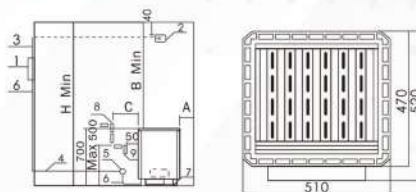

Model	Power (Kw)	Sauna Room			Min. Distance To Heater		
		Min. Capacity	Max. Capacity	Height	Min. A From Side Wall To Back Wall	Min. Suspension Ceiling	Min. B For Guard Bar and Upper Stool
HSAV-10.5	10.5	9	15	190	12	120	15
HSAV-12	12.0	10	18	210	16	140	20
HSAV-15	15.0	14	24	210	16	140	20
HSAV-18	18.0	15	27	210	20	150	25

Item No.	Model	Power	Applicable Space (m ³)
13022	HSAV-10.5	10.5KW	9-15
13023	HSAV-12	12.0KW	10-18
13024	HSAV-15	15.0KW	14-24
13025	HSAV-18	18.0KW	15-27

Installation dimension

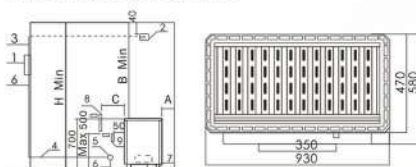

Model	Power (Kw)	Sauna Room			Min. Distance To Heater		
		Min. Capacity	Max. Capacity	Height	Min. A From Side Wall To Back Wall	Min. Suspension Ceiling	Min. B For Guard Bar and Upper Stool
HSAV-21	21.0	19	31	220	20	160	25
HSAV-24	24.0	24	38	230	20	170	25
HSAV-27	27.0	30	46	240	20	180	25
HSAV-30	30.0	37	53	240	20	180	25

Item No.	Model	Power	Applicable Space (m ³)
13026	HSAV-21	21.0KW	19-31
13027	HSAV-24	24.0KW	24-38
13028	HSAV-27	27.0KW	30-46
13029	HSAV-30	30.0KW	37-53

Installation dimension

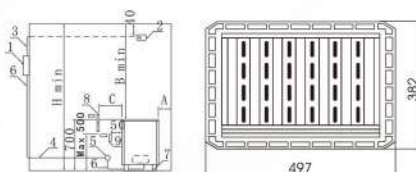

Type	Power (Kw)	Sauna Room			Min. Distance To Heater		
		Min. Capacity	Max. Capacity	Height	Min. A From Side Wall To Back Wall	Min. Suspension Ceiling	Min. B For Guard Bar and Upper Stool
-	10.5	9	15	190	12	120	15
-	12.0	10	18	210	16	140	20
-	15.0	14	24	210	16	140	20

Item No.	Model	Power	Applicable Space (m ³)
61006	HSA-105	10.5KW	9-15
61007	HSA-120	12.0KW	10-18
61008	HSA-150	15.0KW	14-24
61009	HSA-180	18.0KW	15-27

HJM



Installation dimension

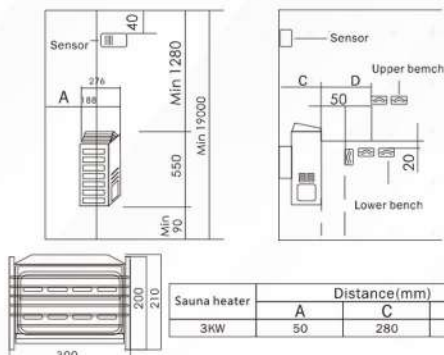

Being light and elegant, it is applicable for luxurious VIP room and households. There are coated and full stainless steel casings available for customers

Item No.	Model	Power	Applicable Space (m ³)
13021	HJM-30BS	3.0KW	2-4
13022	HJM-36BS	3.6KW	2-4

HSCA



Installation dimension

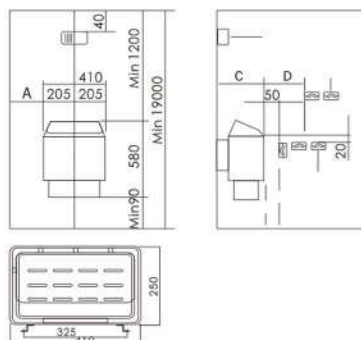

Sauna Heater Distance	3KW	4.5KW	6KW	8KW	9KW
A (mm)	50	80	100	130	130
C (mm)	280	280	280	300	300
D (mm)	80	100	150	200	200

Item No.	Model	Power	Applicable Space (m ³)
13001	HSCA-03A	3.0KW	2-4
13002	HSCA-4.5A	4.5KW	3-6
13003	HSCA-06A	6.0KW	5-9
13004	HSCA-08A	8.0KW	8-12
13005	HSCA-09A	9.0KW	9-13

HSCA



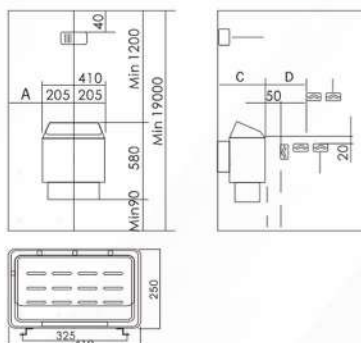

Installation dimension



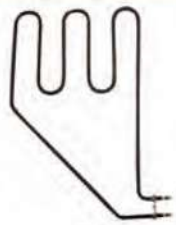
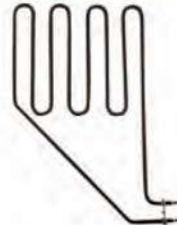
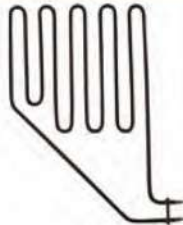
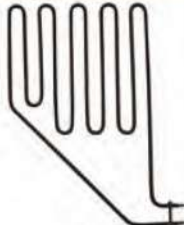

Sauna Heater Distance	3KW	4.5KW	6KW	8KW	9KW
A (mm)	50	80	100	130	130
C (mm)	280	280	280	300	300
D (mm)	80	100	150	200	200

Item No.	Model	Power	Applicable Space (m ³)
B13001	HSCA-B-03A	3.0KW	2-4
B13002	SCA-B-4.5A	4.5KW	3-6
B13003	HSCA-B-06A	6.0KW	5-9
B13004	HSCA-B-08A	8.0KW	8-12
B13005	HSCA-B-09A	9.0KW	9-13

				
HSCA-1000W	HSCA-1500W	HSCA-2000W	HSCA-2670W	HSCA-3000W

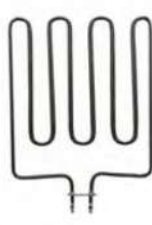
				
HSAV-1500W	HSAV-2000W	HSAV-2500W	HSAV-3000W	HSAV-2000W

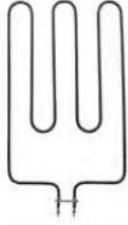
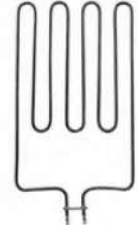
				
HSAWO-2000W	HSAWO-2700W	HSAWO-3000W	HSAWO/SA-1500W	HSAWO/SA-2000W

			
HXN-01 / HXN-02 3-9KW / 9-15KW OUTSIDE CONTROL PANEL	HSX-01 / HSX-02 3-9KW / 9-15KW OUTSIDE DIGITAL CONTROL PANEL	HX-01 EXTERNAL CONTROL ADAPTER	HVK-01 / HVK-02 3-9KW / 12-15KW CONTROL PANEL

				
HGS-A2016 SAUNA CONTROLLER CIRCUIT	HGS-A2018 SENSOR UNIT	HGS-A2019 TIMER	HGS-A2020 CONTACTOR	HGS-A2017 THERMOSTAT



HKS-2001 WOODEN TEMPERATURE MOISTURE METER	HKS-2003 WOODEN TEMPERATURE MOISTURE METER	HKS-2004 WOODEN TEMPERATURE MOISTURE METER	HKS-2005 WOODEN TEMPERATURE MOISTURE METER	HKS-2006 WOODEN TEMPERATURE MOISTURE METER

HKS-2002 WOODEN TEMPERATURE MOISTURE METER	HKS-2010 WOODEN TEMPERATURE MOISTURE METER	HKS-2008 WOODEN TEMPERATURE MOISTURE METER	HKS-2012 WOODEN TEMPERATURE MOISTURE METER	HKS-2014 WOODEN TEMPERATURE MOISTURE METER

HK-018 WOODEN TEMPERATURE MOISTURE METER	HK-020 WOODEN CLOCK	HKS-2506 WOODEN CLOCK	HK-015 WOODEN TEMPERATURE MOISTURE METER	HK-017 WOOD-FRAME TEMPERATURE

HK-033 SAUNA ROOM VENTILATION	HKS-2502 SAUNA ROOM VENTILATION	HKS-2503 SAUNA ROOM VENTILATION	HKS-2504 SAUNA ROOM VENTILATION	HKS-2505 SAUNA ROOM VENTILATION

HK-035 SAND TIMER	HKS-2507 SAND TIMER	HKS-2508 SAND TIMER	HKS-2511 SAND TIMER	HKS-2510 SAND TIMER





HORBO

STEAM ROOM SERIES



STEAM ROOM

Model	Size (mm)
H6A	2460*1800*2150
H8A	3050*1800*2150
H10A	3640*1800*2150
H12A	4230*1800*2150
H14A	4280*1800*2150
H16A	5410*1800*2150
H2B	1260*1020*2150
H4B	1800*1280*2150
H6B	1800*1870*2150
H8B	1800*2460*2150
H10B	1800*3050*2150
H12B	1800*3740*2150
H14B	1800*4230*2150
H16B	1800*4820*2150
H10C	2500*2120*2250
H12C	3080*2120*2250
H14C	3660*2120*2250
H16C	4240*2120*2250
H18C	4900*2120*2250
H20C	5480*2120*2250
H4D	2120*1340*2250
H6D	2120*1340*2250
H7D	2120*1920*2250
H8D	2120*1920*2250
H10D	2120*2500*2250
H12D	2120*3080*2250
H14D	2120*3660*2250
H2G	1270*1340*2250
H12E	2500*3100*2200
H16E	3700*3100*2200
H18E	4300*3100*2200
H20E	4900*3100*2200
H8F	3100*1300*2200
H10F	3100*1900*2200
H12F	3100*2500*2200
H14F	3100*3100*2200
H16F	3100*3700*2200
H18F	3100*4300*2200
H20F	3100*4900*2200

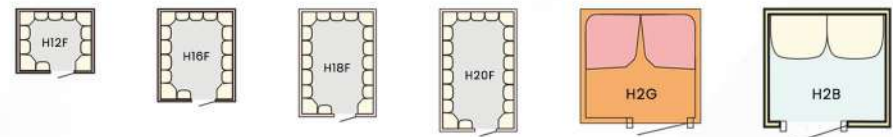
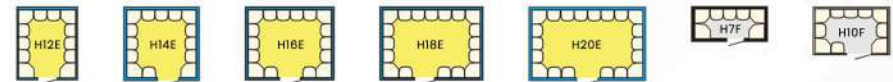
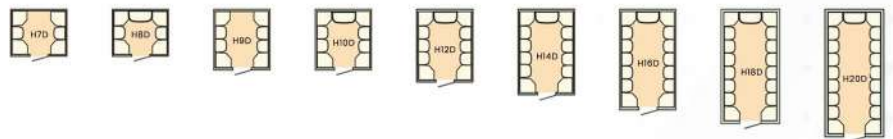
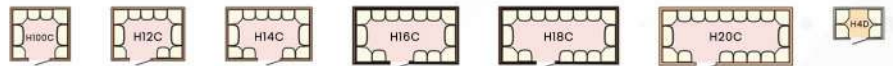
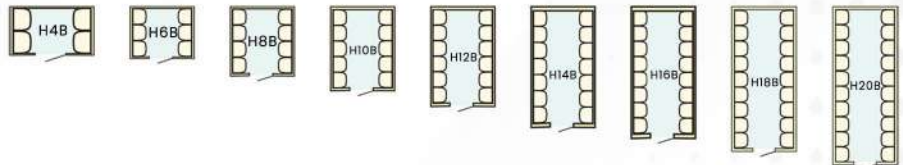
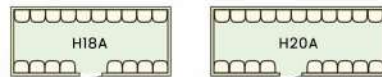
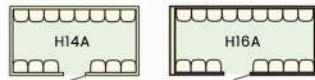
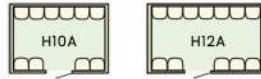
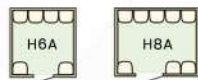

The structure of steam room

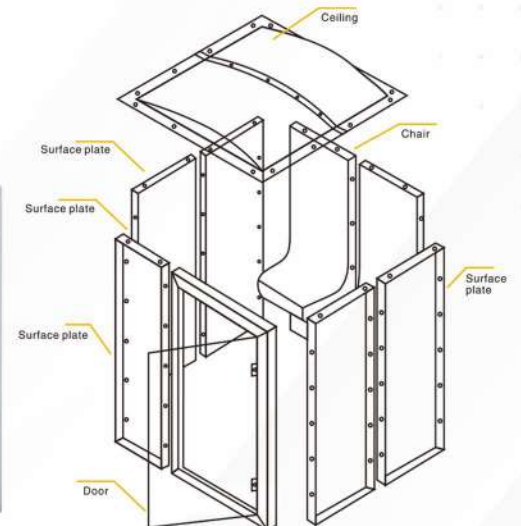



Material: Tempered glass, Acrylic
304Stainless steel / Aluminium alloy

Control system: Smart control system

Function: Intelligent touch screen wireless control panel, FM radio CD player, MP3, Temperature / Time adjusting with top light, 4.5kw steam generator, Lock function, Moveable thermotherapy shower tap

Others:

1. Frame Color (Black, Grey)
2. Plate Material option: Imported Acrylic, Chinese Acrylic
3. Steam generator option: Imported steam generator
4. Installation accessories.



Product Structure:

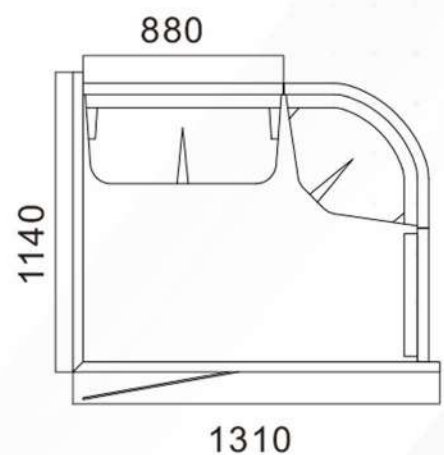
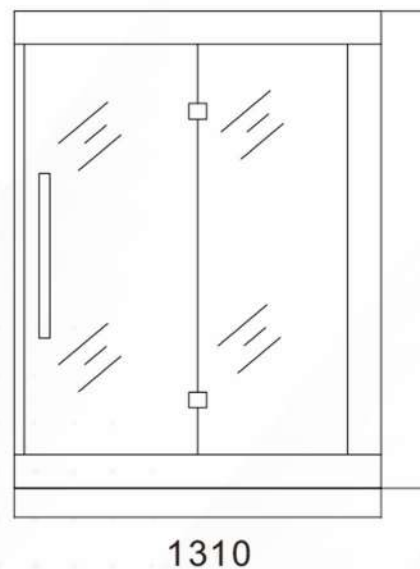

HKDL-02A

Product Size: 1310x1140x2150mm



LUXURY STEAM ROOM



Material: Tempered glass, Acrylic 304Stainless steel/ Aluminium alloy

Control system: Smart control system

Function: Temperature/Time adjusting, top light, 4.5-18KW steam generator

Others:

1. Frame Color (Black,Grey)
2. Plate Material option: Imported Acrylic, Chinese Acrylic
3. Steam generator option: Imported steam generator
4. Installation accessories.



Product Structure:

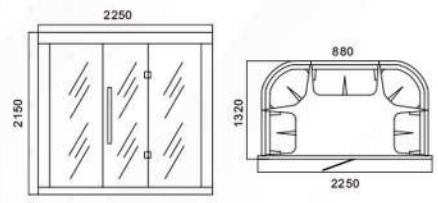

HKDL-06B

Product Size: 2250x1320x2150mm

Product Structure:

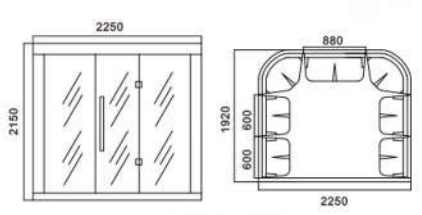

HKDL-08B

Product Size: 2250x1920x2150mm

Product Structure:

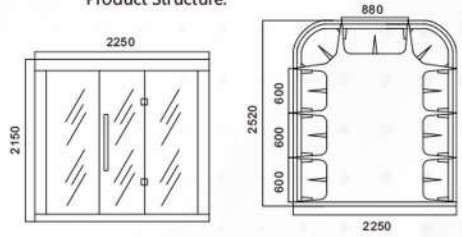

HKDL-10B

Product Size: 2250x2520x2150mm

MORE PRODUCT STRUCTURE

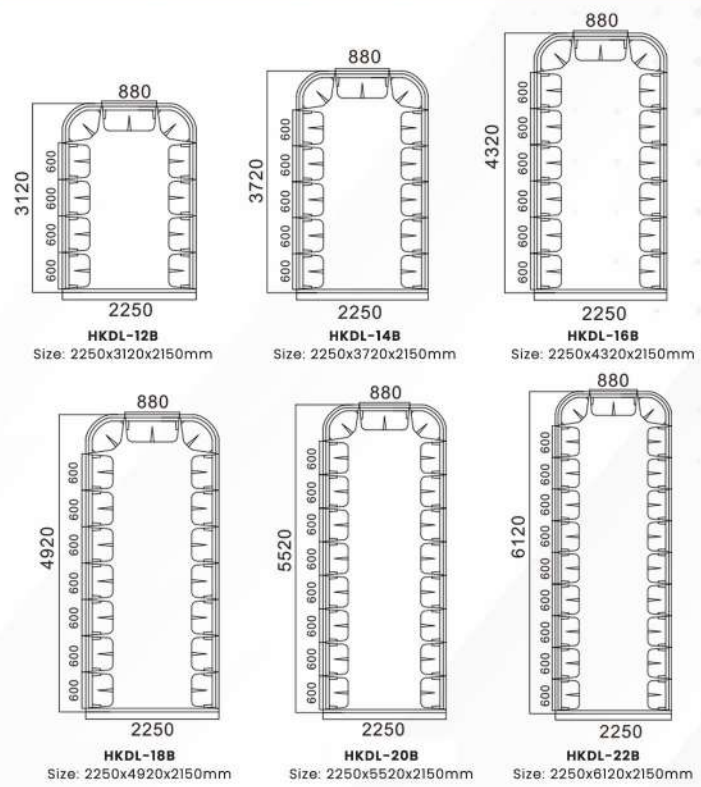

TECHNICAL CHARACTERISTICS



Model	Power (kw)	Voltage (V)	Current (A)	Room (m ³)	AWG	Dimensions	Gross weight
HST-30	3.0	200-240	13.6	2.5-5	3*11	300*130*230	6Kg
HST-40	4.0	200-240	18.2	5-6	3*10	395*135*395	10.5-11
HST-50	5.0	200-240	22.7	5-6	3*9		
HST-60	6.0	380-415	9.1	6-7	5*13	445*135*395	15.6-16.2
		200-240	27.3		3*8		
HST-70	7.0	380-415	9.1	7-9	5*13	445*135*395	15.6-16.2
		200-240	31.8		3*8		
HST-80	8.0	380-415	11.4	9-10	5*12	500*200*520	15.6-18
		200-240	36.4		3*7		
HST-90	9.0	380-415	13.6	10-12	5*11	500*200*520	15.6-18
		200-240	41		3*7		
HST-105	10.5	380-415	16	12-15	5*11	500*200*520	15.6-18
HST-120	12.0	380-415	18	15-18	5*10		
HST-150	15.0	380-415	23	18-21	5*9		
HST-180	18.0	380-415	27.3	21-24	5*8		



TECHNICAL CHARACTERISTICS

Model	Power (kw)	Voltage (V)	Dimensions (mm)	Applicable space (m ³)
HHA-40	4.0	220/380	210*650*430	5
HHA-60	6.0	220/380	210*650*430	6
HHA-80	8.0	220/380	210*650*430	8
HHA-90	9.0	220/380	210*650*430	9
HHA-120	12	380	260*650*600	12
HHA-150	15	380	260*650*600	15
HHA-180	18	380	260*650*600	18



TECHNICAL CHARACTERISTICS

Model	Power (kw)	Voltage (V)	Current (A)	Room (m ³)	AWG	Dimensions	Gross weight
HDON-45	4.5	200-240	20	3-5	3*10	530*225*410	14
		380-415	7		5*14		
HDON-60	6.0	200-240	27.3	6-7	3*8	530*225*410	14
		380-415	9		5*13		
HDON-90	9.0	200-240	41	10-12	3*7	530*225*470	19
		380-415	14		5*11		
HDON-105	10.5	200-240	16	12-15	5*11	530*225*470	19
HDON-120	12.0	380-415	18	15-18	5*10		
HDON-150	15.0	380-415	23	18-21	5*9		
HDON-180	18.0	380-415	27.3	21-25	5*8		

HORBO

LEISURE FURNITURE SERIES





HORBO

SPA HOT TUB

SERIES





SPA HOT TUB SERIES

HJY-8605



Dimensions	5850x2200x1500mm
Capacity	11000L
Seating	2 seats
Dry Weight	1500 kg
Filled Weight	11000L
Total Jets	24pcs

EQUIPMENT	
Counter Current Pump	1x2.8KW/380V
High Performance Pumps	1x2HP
Circulation Pump	1x1.0HP
9-speed flow controller	1pc
LED Light	1pc
Ozone	1pc
Plastic wood skirt LED light	1pc
Inlet/outlet	1pc
Sand filter P400	1pc
Cartridge filter	1pc
Headrest	2pcs
Fiberglass Base Tray	1pc





SPA HOT TUB SERIES

HJY8801



Dimensions	6900x2220x1550mm
Capacity	9000L
Seating	2 seats
Dry Weight	1600kg
Filled Weight	9000kg
Total Jets	24pcs

EQUIPMENT

Counter Current Pump	1X2.8KW / 380V
High Performance Pumps	1X2HP
Circulation Pump	1X1HP
Heater	1X3KW
LED Light	1pc
Synthetic Cabinet	1pc
Drain	1pc
Filtration	2pc
Headrest	2pc
Sand Filter P400 (Options)	
9-speed flow controller	1pc



HJY8601



Dimensions	5870x2200x1520mm
Capacity	7600L (Approx)
Seating	5 seats + 1 Lounger
Dry Weight	1275kg (Approx)
Filled Weight	8000kg (Approx)
Total Jets	59pcs

EQUIPMENT

High Performance Pumps	2x2HP, 2x3HP
Circulation Pump	2x0.5HP
Heater	2x3kw
LED Light	2pc
Blower	400W
Aroma therapy	1pc
Ozone	1pc
Controller	2pcs
Synthetic Cabinet	1pc
Drain	1pc
Filtration Sie	1pc
High Density Foam Insulation	1pc
Headrest	5pcs



HJY8602



Dimensions	5850x2200x1600mm
Capacity	8500L (Approx)
Seating	4 seats
Dry Weight	1300kg
Filled Weight	11000Kg
Total Jets	53pcs

EQUIPMENT

High Performance Pumps	3x3HP
Circulation Pump	1x0.5HP
Heater	1x3kw
LED Light	1pc
Blower	400W
Aromatherapy	1pc
Ozone	1pc
Controller	1pcs
Synthetic Cabinet	1pc
Drain	1pc
Filtration	1pc
High Density Foam Insulation	1pc
Headrest	2pcs



HJY8802



Dimensions	5700x2240x1520mm
Capacity	7600L
Seating	2 seats
Dry Weight	1275Kg
Filled Weight	8000Kg
Total Jets	46pcs

EQUIPMENT

High Performance Pumps	3x3HP
Circulation Pump	1x0.5HP
Heater	1x3kw
LED Light	1pc
Ozone	1pc
Controller	1pc
Synthetic Cabinet	1pc
Drain	1pc
Filtration	1pc
High Density Foam Insulation	1pc
Headrest	2pcs
Fiberglass Base Tray	1pc
Lockable Thermo Hard Cover	1pc
Treated Timber Frame	1pc





SPA HOT TUB SERIES

HJY8603



Dimensions	4180x2200x1430mm
Capacity	5600L (Approx)
Seating	2 seats
Dry Weight	1000kg
Filled Weight	6500kg
Total Jets	33pcs

EQUIPMENT

High Performance Pumps	3x3HP
Circulation Pump	1x0.5HP
Heater	1x3kw
LED Light	1pc
Blower	400W
Aromatherapy	1pc
Ozone	1pc
Controller	1pcs
Synthetic Cabinet	1pc
Drain	1pc
Filtration	1pc
High Density Foam Insulation	1pc
Headrest	2pcs



HJY8801-A



Dimensions	5870x2280x1520mm
Capacity	7600L
Seating	2 seats + 1 Lounger
Dry Weight	1275kg
Filled Weight	8000kg
Total Jets	61 pcs

EQUIPMENT

High Performance Pumps	3x3HP
Circulation Pump	2x0.5HP
Heater	2x3kw
LED Light	1pc
Blower	400W
Aromatherapy	1pc
Ozone	1pc
Controller	2pcs
Synthetic Cabinet	1pc
Drain	1pc
Filtration	1pc
High Density Foam Insulation	1pc
Headrest	3pcs
Fiberglass Base Tray	1pc



HJY8803



Dimensions	4560x2240x1420mm
Capacity	5600L
Seating	3 seats
Dry Weight	1000kg
Filled Weight	6500kg
Total Jets	43pcs

EQUIPMENT

High Performance Pumps	3x3HP
Circulation Pump	1x0.5HP
Heater	1x3kw
LED Light	1pc
Ozone	1pc
Controller	1pc
Synthetic Cabinet	1pc
Drain	1pc
Filtration	1pc
High Density Foam Insulation	1pc
Headrest	2pcs
Fiberglass Base Tray	1pc
Lockable thermo Hard Cover	1pc
Treated Timber Frame	1pc



HJY8001



Dimensions	4000x2200x950mm
Capacity	3000L
Seating	6 seats + 2 loungers
Dry Weight	860kg
Filled Weight	4230kg
Total Jets	118pcs

EQUIPMENT

High Performance Pumps	2X3HP, 1x2HP
Circulation Pump	1x0.5HP
Heater	1x3kw
LED Light	1pc
Blower	400W
Aromatherapy	1pc
Ozone	1pc
Controller	1pc
Synthetic Cabinet	1pc
Drain	1pc
Filtration	2pcs
High Density Foam Insulation	1pc
Headrest	1pcs
Fiberglass Base Tray	1pc





SPA HOT TUB SERIES

HJY8005



Dimensions	2100x1050x760mm
Capacity	600L
Seating	2 seats
Dry Weight	180kg
Filled Weight	780kg
Total Jets	23pcs

EQUIPMENT

High Performance Pumps	1x2HP 2speed
Heater	4x2kw
LED Light	1pc
Blower	300W
Ozone	1pc
Controller	1pc
Synthetic Cabinet	1pc
Drain	1pc
Filtration	1pc
High Density Foam Insulation	1pc
Headrest	2pcs
Fiberglass Base Tray	1pc



HJY8005A



Dimensions	2100x1050x760mm
Capacity	600L
Seating	1 Lounger
Dry Weight	180Kg
Filled Weight	780Kg
Total Jets	23pcs

EQUIPMENT

High Performance Pumps	1x2HP 2speed
Heater	1x2kw
LED Light	1pc
Ozone	1pc
Controller	1pc
Synthetic Cabinet	1pc
Drain	1pc
Filtration	1pc
Headrest	1pc
Fiberglass Base Tray	1pc



HJY8006



Dimensions	2100x1650x790mm
Capacity	950L
Seating	2 Loungers + 1seat
Dry Weight	300kg
Filled Weight	1250kg
Total Jets	24pcs

EQUIPMENT

High Performance Pumps	1x3HP 2speed
Heater	1x3kw
LED Light	1pc
Ozone	1pc
Controller	1pc
Synthetic Cabinet	1pc
Drain	1pc
Filtration	1pc
High Density Foam Insulation	1pc
Headrest	2pcs
Fiberglass Base Tray	1pc



HJY8020



Dimensions	2000x2000x900mm
Capacity	1400L
Seating	4 seats + 1 Lounger
Dry Weight	350kg
Filled Weight	1750kg
Total Jets	33pcs

EQUIPMENT

High Performance Pumps	1x3HP
Circulation Pump	41x0.5HP
Heater	1x3kw
LED Light	1pc
Ozone	1pc
Controller	1pc
Synthetic Cabinet	1pc
Drain	1pc
Filtration	1pc
High Density Foam Insulation	1pc
Headrest	3pcs
Fiberglass Base Tray	1pc





SPA HOT TUB SERIES

HJY8007



Dimensions	2200x2200x930mm
Capacity	1250L
Seating	3 Seats + 2 Loungers
Dry Weight	380Kg
Filled Weight	1630kg
Total Jets	42pcs

EQUIPMENT

High Performance Pumps	2x2HP
Circulation Pump	1x0.5HP
Heater	1x3kw
LED Light	1pc
Ozone	1pc
Controller	1pc
Synthetic Cabinet	1pc
Drain	1pc
Filtration	1pc
High Density Foam Insulation	1pc
Headrest	3pcs
Fiberglass Base Tray	1pc

HJY8008



Dimensions	2200x2200x930mm
Capacity	1280L
Seating	5seats + 1 Lounger
Dry Weight	380 Kg
Filled Weight	1660 g
Total Jets	45pcs

EQUIPMENT

High Performance Pumps	2x2HP
Circulation Pump	1x0.5HP
Heater	1x3kw
LED Light	1pc
Ozone	1pc
Controller	1pc
Synthetic Cabinet	1pc
Drain	1pc
Filtration	1pc
High Density Foam Insulation	1pc
Headrest	3pcs
Fiberglass Base Tray	1pc

HJY8805



Dimensions	2180x1600x880mm
Capacity	1100L
Seating	2 seats + Lounger
Dry Weight	280kg
Filled Weight	1380kg
Total Jets	46pcs

EQUIPMENT

High Performance Pumps	1x3HP
Circulation Pump	1x0.5HP
Heater	1x3kw
LED Light	1pc
Blower	300W
Aromatherapy	1pc
Ozone	1pc
Controller	1pc
Synthetic Cabinet	1pc
Drain	1pc
Filtration	1pc
High Density Foam Insulation	1pc
Headrest	3pcs
Fiberglass Base Tray	1pcs

HJY8806



Dimensions	2180x1950x880mm
Capacity	1480L
Seating	4 seats
Dry Weight	380kg
Filled Weight	1950kg
Total Jets	41pcs

EQUIPMENT

High Performance Pumps	2x2HP
Circulation Pump	1x0.5HP
Heater	1x3kw
LED Light	1pc
Blower	400W
Aromatherapy	1pc
Ozone	1pc
Controller	1pc
Synthetic Cabinet	1pc
Drain	1pc
Filtration	1pc
High Density Foam Insulation	1pc
Headrest	3pcs
Fiberglass Base Tray	1pc



SPA HOT TUB SERIES

HJY8807



Dimensions	2130x2130x880mm
Capacity	1480L
Seating	3 seats + Lounger
Dry Weight	350kg
Filled Weight	1950kg
Total Jets	57pcs

EQUIPMENT

High Performance Pumps	2X3HP
Circulation Pump	1x0.5HP
Heater	1x3kw
LED Light	1pc
Blower	400W
Aromatherapy	1pc
Ozone	1pc
Controller	1pc
Synthetic Cabinet	1pc
Drain	1pc
Filtration	1pc
High Density Foam Insulation	1pc
Headrest	1pc
Fiberglass Base Tray	1pc

HJY8808



Dimensions	2130x2130x880mm
Capacity	1500L
Seating	8 seats
Dry Weight	380kg
Filled Weight	1900kg
Total Jets	52pes

EQUIPMENT

High Performance Pumps	2x3HP
Circulation Pump	1x0.5HP
Heater	1x3kw
LED Light	1pc
Blower	400W
Aromatherapy	1pc
Ozone	1pc
Controller	1pc
Synthetic Cabinet	1pc
Drain	1pc
Filtration	1pc
High Density Foam Insulation	1pc
Headrest	3pcs
Fiberglass Base Tray	1pc

HJY8809



Dimensions	2130mmx2130mmx880mm
Capacity	1480L
Seating	3 seats + 2 Loungers
Dry Weight	380Kg
Filled Weight	1950Kg
Total Jets	57pcs

EQUIPMENT

High Performance Pumps	2x3HP
Circulation Pump	1x0.5HP
Heater	1x3kw
LED Light	1pc
Blower	400w
Aromatherapy	1pc
Ozone	1pc
Controller	1pc
Synthetic Cabinet	1pc
Drain	1pc
Filtration	1pc
High Density Foam Insulation	1pc
Headrest	3pcs
Fiberglass Base Tray	1pc

HJY8810



Dimensions	2130x2130x880mm
Capacity	1450L
Seating	4 seats + 1 Lounger
Dry Weight	380Kg
Filled Weight	1880Kg
Total Jets	2pcs

EQUIPMENT

High Performance Pumps	2x3HP
Circulation Pump	41x0.5HP
Heater	1x3kw
LED Light	1pC
Blower	400w
Aromatherapy	1pc
Ozone	1pc
Controller	1pc
Synthetic Cabinet	1pc
Drain	1pc
Filtration	1pc
High Density Foam Insulation	1pc
Headrest	3pcs
Fiberglass Base Tray	1pc



SPA HOT TUB SERIES

HJY8811



Dimensions	2250x2250x880mm
Capacity	1500L
Seating	3 seats + 2 Loungers
Dry Weight	380Kg
Filled Weight	1900Kg
Total Jets	69pcs

EQUIPMENT

High Performance Pumps	2x3HP
Circulation Pump	4x0.5HP
Heater	1x3kw
LED Light	1pc
Blower	400w
Aromatherapy	1pc
Ozone	1pc
Controller	1pc
Synthetic Cabinet	1pc
Drain	1pc
Filtration	1pc
High Density Foam Insulation	1pc
Headrest	3pcs
Fiberglass Base Tray	1pc

HJY8812



Dimensions	2250x2250x860mm
Capacity	1450L
Seating	5 seats + 1 Lounger
Dry Weight	380kg
Filled Weight	1880kg
Total Jets	76pcs

EQUIPMENT

High Performance Pumps	2x3HP
Circulation Pump	4x0.5HP
Heater	1x3kw
LED Light	1pc
Blower	400w
Aromatherapy	1pc
Ozone	1pc
Controller	1pc
Synthetic Cabinet	1pc
Drain	1pc
Filtration	1pc
High Density Foam Insulation	1pc
Headrest	3pcs
Fiberglass Base Tray	1pc

HJY8011



Dimensions	2200x2200x940mm
Capacity	1480L
Seating	4 seats + 1 Lounger
Dry Weight	350kg
Filled Weight	1950Kg
Total Jets	50pcs

EQUIPMENT

High Performance Pumps	2x2HP
Circulation Pump	4x0.5HP
Heater	1x3kw
LED Light	1pc
Blower	400w
Aromatherapy	1pc
Ozone	1pc
Controller	1pc
Synthetic Cabinet	1pc
Drain	1pc
Filtration	1pc
High Density Foam insulation	1pc
Headrest	3pcs
Fiberglass Base Tray	1pc

HJY8012



Dimensions	2200x2200x940mm
Capacity	1480L
Seating	3 seats + 2 Loungers
Dry Weight	380kg
Filled Weight	1950kg
Total Jets	61pcs

EQUIPMENT

High Performance Pumps	2x2HP
Circulation Pump	1x0.5HP
Heater	1x3kw
LED Light	1pc
Blower	400w
Aromatherapy	1pc
Ozone	1pc
Controller	1pc
Synthetic Cabinet	1pc
Drain	1pc
Filtration	1pc
High Density Foam Insulation	1pc
Headrest	3pcs
Fiberglass Base Tray	1pc



SPA HOT TUB SERIES

HJY8002



Dimensions	2880x2200x950mm
Capacity	2030L
Seating	4 seats + 2 Loungers
Dry Weight	450kg
Filled Weight	2860kg
Total Jets	68pcs

EQUIPMENT

High Performance Pumps	2x3HP
Circulation Pump	41x0.5HP
Heater	1x3kw
LED Light	1pc
Blower	400w
Aromatherapy	1pc
Ozone	1pc
Controller	1pc
Synthetic Cabinet	1pc
Drain	1pc
Filtration	1pc
High Density Foam Insulation	1pc
Headrest	3pcs
Fiberglass Base Tray	1pc

HJY8003



Dimensions	2350x2350x950mm
Capacity	1700L
Seating	3 seats + 2 Loungers
Dry Weight	400kg
Filled Weight	2200kg
Total Jets	59pcs

EQUIPMENT

High Performance Pumps	2x3HP
Circulation Pump	1x0.5HP
Heater	1x3kw
LED Light	1pc
Blower	400w
Aromatherapy	1pc
Ozone	1pc
Controller	1pc
Synthetic Cabinet	1pc
Drain	1pc
Filtration	1pc
High Density Foam insulation	1pc
Headrest	3pc
Fiberglass Base Tray	1pc

HJY8009



Dimensions	1830x1230x700mm
Capacity	800L
Seating	2 Loungers + 1 seat
Dry Weight	190kg
Filled Weight	900kg
Total Jets	17pcs

EQUIPMENT

High Performance Pumps	1x2HP 2speed
Heater	1x2kw
LED Light	1pc
Controller	1pc
Synthetic Cabinet	1pc
Drain	1pc
Headrest	1pcs

HJY8013



Dimensions	2100x1550x860mm
Capacity	1100L
Seating	2 seats + 1 Lounger
Dry Weight	280g
Filled Weight	1380Kg
Total Jets	39pcs

EQUIPMENT

High Performance Pumps	4x2HP
Circulation Pump	4x0.5HP
Heater	1x3kw
LED Light	1pc
Blower	300W
Aromatherapy	1pc
Ozone	1pc
Controller	1pc
Synthetic Cabinet	1pc
Drain	1pc
Filtration	1pc
High Density Foam Insulation	1pc
Headrest	3pcs
Fiberglass Base Tray	1pc



SPA HOT TUB SERIES

HJY8015



Dimensions	2200x2200x940mm
Capacity	1500L
Seating	7 Seats
Dry Weight	380kg
Filled Weight	1900kg
Total Jets	42pcs

EQUIPMENT

High Performance Pumps	2x2HP
Circulation Pump	1x0.5HP
Heater	1x3kw
LED Light	1pc
Blower	400w
Aromatherapy	1pc
Ozone	1pc
Controller	1pc
Synthetic Cabinet	1pc
Drain	1pc
Filtration	1pc
High Density Foam Insulation	1pc
Headrest	4pcs
Fiberglass Base Tray	1pc

HJY8016



Dimensions	2200x2200x940mm
Capacity	1450L
Seating	5 seats + 1 Lounger
Dry Weight	380Kg
Filled Weight	1880Kg
Total Jets	44pcs

EQUIPMENT

High Performance Pumps	2x2HP
Circulation Pump	1x0.5HP
Heater	1x3kw
LED Light	1pc
Blower	400W
Aromatherapy	1pc
Ozone	1pc
Controller	1pc
Synthetic Cabinet	1pc
Drain	1pc
Filtration	1pc
High Density Foam Insulation	1pc
Headrest	3pcs
Fiberglass Base Tray	1pc

HJY8017



Dimensions	2200x2200x940mm
Capacity	1550L
Seating	4 seats + 1 Lounger
Dry Weight	380Kg
Filled Weight	1920Kg
Total Jets	59pcs

EQUIPMENT

High Performance Pumps	2x2HP
Circulation Pump	1x0.5HP
Heater 1818	1x3kw
LED Light	1pc
Blower	400w
Aromatherapy	1pc
Ozone	1pc
Controller	1pc
Synthetic Cabinet	1pc
Drain	1pc
Filtration	1pc
High Density Foam Insulation	1pc
Headrest	3pcs
Fiberglass Base Tray	1pc

HJY8018



Dimensions	2200x2200x940mm
Capacity	1500L
Seating	5 seats + 2 Loungers
Dry Weight	380kg
Filled Weight	1900kg
Total Jets	69pcs

EQUIPMENT

High Performance Pumps	2x2HP
Circulation Pump	1x0.5HP
Heater	1x3kw
LED Light	1pc
Blower	400W
Aromatherapy	1pc
Ozone	1pc
Controller	1pc
Synthetic Cabinet	1pc
Drain	1pc
Filtration	1pc
High Density Foam Insulation	1pc
Headrest	3pcs
Fiberglass Base Tray	1pc



SPA HOT TUB SERIES

HJY8010



Dimensions	2200x2200x240mm
Capacity	1400L
Seating	6 seats
Dry Weight	380kg
Filled Weight	1780kg
Total Jets	44pcs

EQUIPMENT	
High Performance Pumps	2x2HP
Circulation Pump	1x0.5HP
Heater	1x3kw
LED Light	1pc
Blower	300W
Ozone	1pc
Controller	1pc
Synthetic Cabinet	1pc
Drain	1pc
Filtration	1pc
High Density Foam insulation	1pc
Headrest	4pcs
Fiberglass Base Tray	1pc

HJY8808



Dimensions	1900x1900x940mm
Capacity	1450L
Seating	4 seats
Dry Weight	360kg
Filled Weight	1920g
Total Jets	16pcs

EQUIPMENT	
High Performance Pumps	1x2HP
Circulation Pump	1x0.5HP
Heater	1x3kw
LED Light	1pc
Blower	400W
Aromatherapy	1pc
Ozone	1pc
Controller	1pc
Synthetic Cabinet	1pc
Drain	1pc
Filtration	1pc
High Density Foam Insulation	1pc
Fiberglass Base Tray	1pc

CONTROL PANEL



CANADIAN GECKO CONTROL SYSTEM



AMERICAN BALBOA CONTROL SYSTEM



P23B32 SPA CONTROL



P15B66 SPA CONTROL

ACRYLIC SHELL



6427 Silver white marble



6615 Summer sapphire



6696 White pearlescent



6811 Oceanwave



6878 Midnight



6256 Mayan copper



6240 Mediterranean sunset



9814 Gypsum

SYNTHETIC CABINET COLORS



TAKE COLOR



RED BROWN



GREY



COFFEE

INDOTARA®

PT. INDOTARA PERSADA

Our Marketing Office and After Sales Service Center

Head Office

50/F, Menara BCA Grand Indonesia
Jl. M.H. Thamrin No.1
Jakarta Pusat 10310

021 - 5011 2229

dwt@indotara.id



Semarang Office

Wisma HSBC Lt. 6 Suite 609
Jl. Gajah Mada No.135
Semarang, Jawa Tengah 50134

021 - 5011 2229

smg.dwt@indotara.id



Marketing Office

APL Tower 6th Floor No. 6 Central Park,
Jl. Letjen S. Parman Kav 28,
Jakarta Barat - 11440

021 - 5011 2229

dwt@indotara.id



Medan Office

Sutomo Tower Lantai 5H
Jl. Sutomo Ujung No.28,
Kota Medan, Sumatera Utara 20235

021 - 5011 2229

mdn.dwt@indotara.id



Graha Indotara

Millenium Industrial Estate
Jl. Millenium 22 Blok R3 No. 1
Cikupa, Tangerang - Banten 15720

021 - 5011 2229

dwt@indotara.id



Makassar Office

Fajar Graha Pena Lt. 5
Jl. Urip Sumoharjo No. 20,
Makassar - South Sulawesi 90234

021 - 5011 2229

mks.dwt@indotara.id



Bandung Office

Wisma HSBC Lt. 6 Suite B
Jl. Asia Afrika No. 116
Bandung, Jawa Barat 40112

021 - 5011 2229

bdg.dwt@indotara.id



Balikpapan Office

Panin Tower Lt. 8 - Grand Sudirman
Jl. Jendral Sudirman No.7 Klandasan Ilir,
Balikpapan Kota, Kalimantan Timur 76114

021 - 5011 2229

bpp.dwt@indotara.id



Surabaya Office

Japfa Indoland Center, Tower I Lt. 10/1008
Jl. Jendral Basuki Rahmat 129-137
Surabaya 60271

021 - 5011 2229

sby.dwt@indotara.id



Bali Office

Benoa Square Lt. 2
Jl. Bypass Ngurah Rai No. 21 A Kedonganan,
Kuta Badung - Bali Indonesia 80361

021 - 5011 2229

bali.dwt@indotara.id



Yogyakarta Office

Hartono Mall Yogyakarta Lt. 3
Kaliwaru, Condongcatur,
Sleman, Yogyakarta 55281

021 - 5011 2229

yog.dwt@indotara.id



Singapore Office

Marina Bay Financial Centre Tower 3
17F, 12 Marina Boulevard
Singapore - 018982

021 - 5011 2229

sing.dwt@indotara.id

